

Robert Bosch Power Tools GmbH
70538 Stuttgart
GERMANY

www.bosch-pt.com

1 609 92A 3RE (2017.12) T / 74



1 609 92A 3RE

GTC 400 C Professional



- en** Original instructions
- cn** 正本使用说明书
- tw** 原始使用說明書
- ko** 사용 설명서 원본
- th** หนังสือคู่มือการใช้งานฉบับต้นแบบ
- id** Petunjuk-Petunjuk untuk Penggunaan Orisinal
- vi** Bản gốc hướng dẫn sử dụng



English	Page	6
中文	页	17
中文	頁	26
한국어	페이지	35
ภาษาไทย	หน้า	44
Bahasa Indonesia	Halaman	54
Tiếng Việt	Trang	63

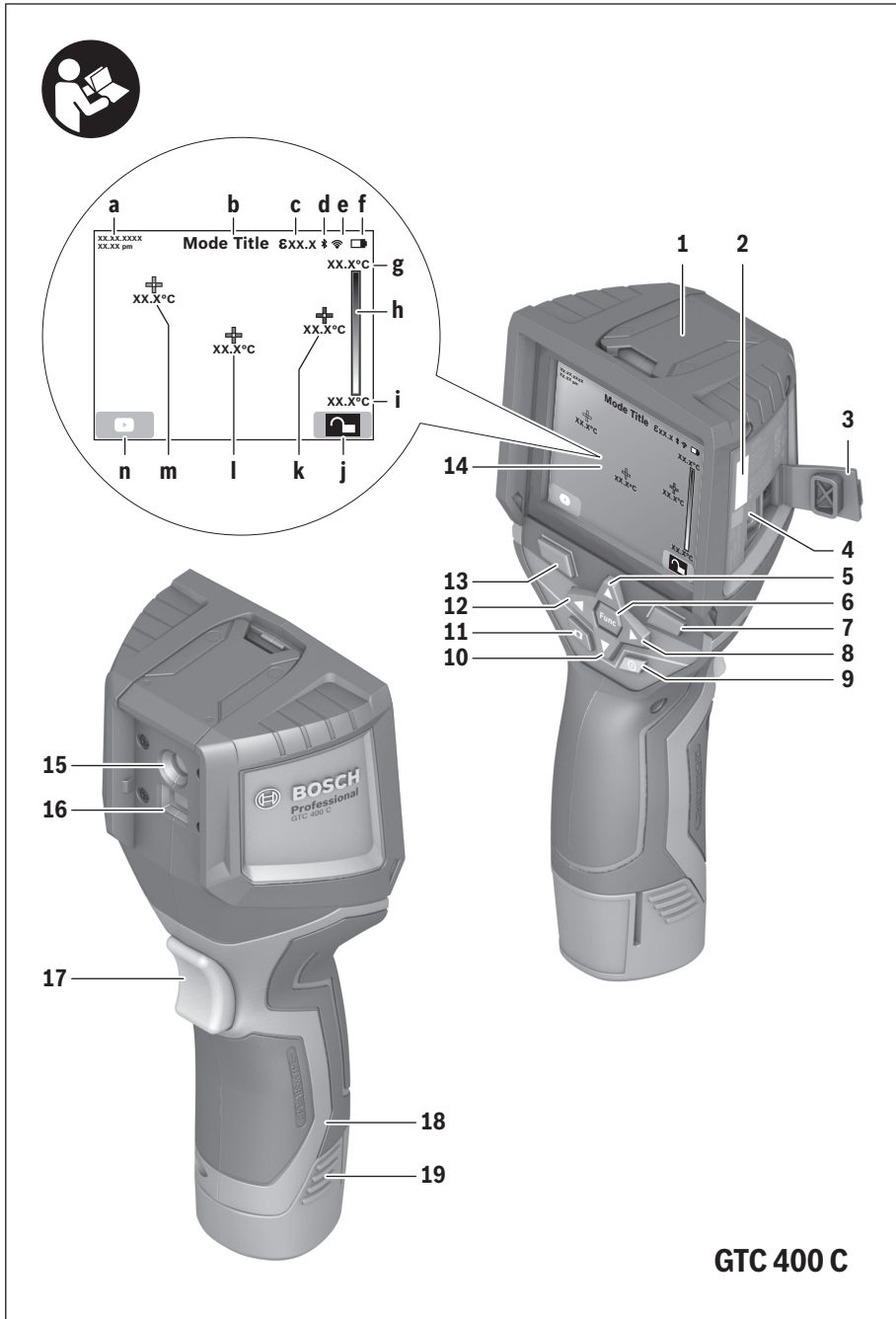

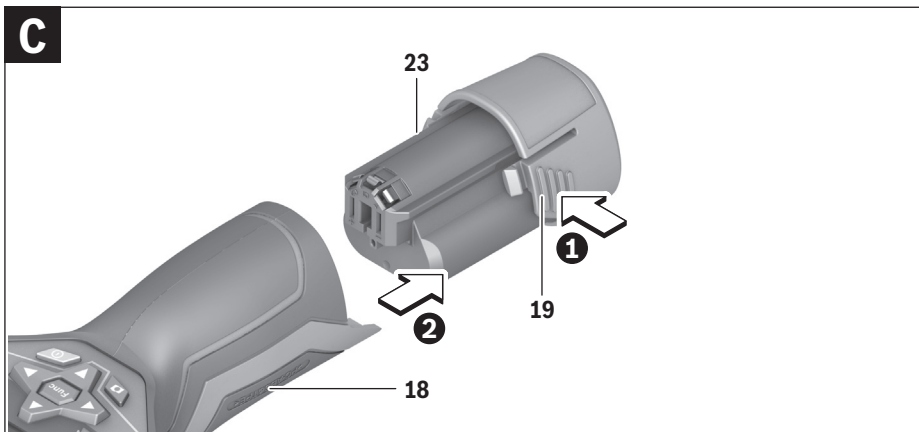
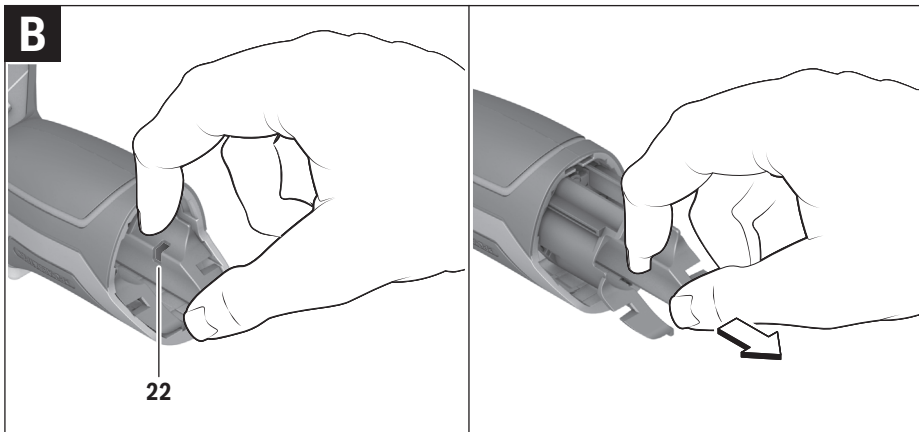
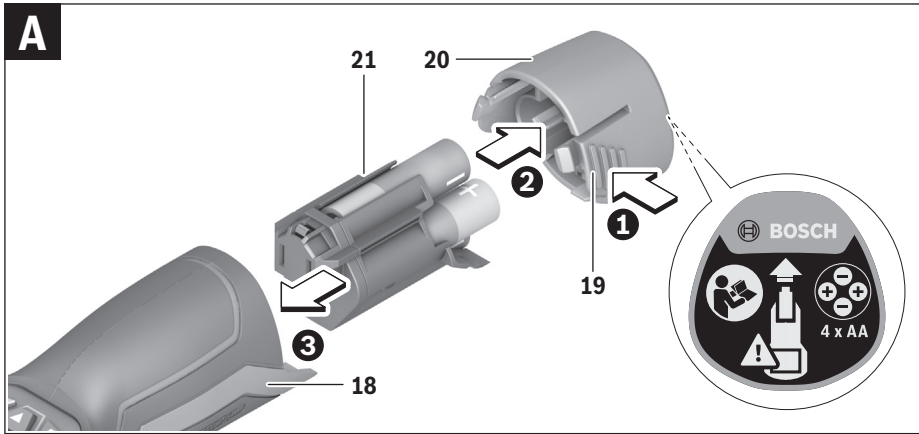

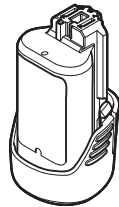

GBA 10,8 V ...
GBA 12 V ...

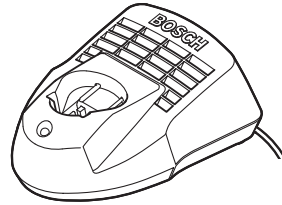

AL 1115 CV
GAL 1215 CV

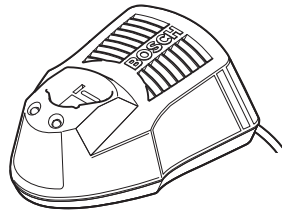

AL 1130 CV
GAL 1230 CV

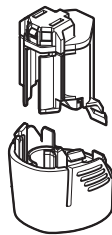

AA1
1 608 M00 C1B

24

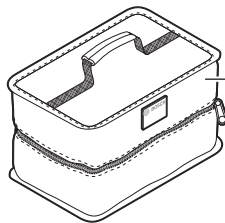
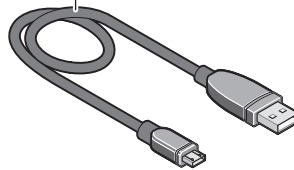

25

1 600 A00 86E

English

Safety Notes



Read and observe all instructions. The integrated protections in the measuring tool may be compromised if the measuring tool is not used in accordance with the instructions provided. **SAVE THESE INSTRUCTIONS FOR FUTURE REFERENCE.**

- ▶ **Have the measuring tool repaired only through qualified specialists using original spare parts.** This ensures that the safety of the measuring tool is maintained.
- ▶ **Do not operate the measuring tool in explosive environments, such as in the presence of flammable liquids, gases or dusts.** Sparks can be created in the measuring tool which may ignite the dust or fumes.
- ▶ **Before any work on the measuring tool itself (e. g. assembling, maintenance, etc.) as well as when transporting and storing, remove the battery pack or the batteries from the measuring tool.**
- ▶ **Do not open the battery pack.** Danger of short-circuiting.



Protect the battery pack against heat, e. g., against continuous intense sunlight, fire, water, and moisture. Danger of explosion.



- ▶ **When battery pack is not in use, keep it away from other metal objects like paper clips, coins, keys, nails, screws, or other small metal objects that can make a connection from one terminal to another.** Shorting the battery terminals together may cause burns or a fire.
- ▶ **Under abusive conditions, liquid may be ejected from the battery pack; avoid contact. If contact accidentally occurs, flush with water. If liquid contacts eyes, additionally seek medical help.** Liquid ejected from the battery pack may cause irritations or burns.
- ▶ **In case of damage and improper use of the battery pack, vapours may be emitted. Provide for fresh air and seek medical help in case of complaints.** The vapours can irritate the respiratory system.
- ▶ **Recharge only with the charger specified by the manufacturer.** A charger that is suitable for one type of battery pack may create a risk of fire when used with another battery pack.
- ▶ **Use the battery pack only in conjunction with your Bosch measuring tool.** This measure alone protects the battery pack against dangerous overload.
- ▶ **The battery pack can be damaged by pointed objects such as nails or screwdrivers or by force applied externally.** An internal short circuit can occur and the battery pack can burn, smoke, explode or overheat.
- ▶ **The non-rechargeable battery adapter is intended only for use in designated Bosch measuring tools and must not be used with power tools.**

- ▶ **Remove the batteries from the measuring tool when not using it for extended periods.** When storing for extended periods, the batteries can corrode and self-discharge.
- ▶ **Protect the measuring tool, particularly the area around the camera and infrared lens, against moisture and snow.** The reception lens could fog up and distort the measurements. Incorrect settings on the tool and other atmospheric influences may make the measurements inaccurate. Objects could be depicted hotter or colder, which may present a danger if touched.
- ▶ **High temperature differences in a thermal image may cause even high temperatures to be shown in a colour associated with low temperatures.** Coming into contact with such an area may cause burns.
- ▶ **Temperature measurements will only be correct if the emissivity setting and the emissivity of the object match.** Objects could be depicted hotter or colder in temperature and/or colour, which may present a danger if touched.
- ▶ **Caution! When using the measuring tool with Bluetooth®, interference with other devices and systems, airplanes and medical devices (e. g., cardiac pacemakers, hearing aids) may occur. Also, the possibility of humans and animals in direct vicinity being harmed cannot be completely excluded. Do not use the measuring tool with Bluetooth® in the vicinity of medical devices, petrol stations, chemical plants, areas where there is danger of explosion, and areas subject to blasting. Do not use the measuring tool with Bluetooth® in airplanes. Avoid operation in direct vicinity of the body over longer periods.**
- ▶ **The measuring tool is equipped with a radio interface. Local operating restrictions, e. g. in airplanes or hospitals, are to be observed.**

Product Description and Specifications

The **Bluetooth®** word mark and logos are registered trademarks owned by Bluetooth SIG, Inc. and any use of such marks by Robert Bosch Power Tools GmbH is under licence.

Intended Use

This thermal imaging camera is designed for the contactless measurement of surface temperatures.

The displayed thermal image shows the temperature distribution of the area captured by the infrared lens and therefore enables temperature deviations to be depicted in different colours.

When used correctly, this makes it possible to examine areas and objects in a contactless manner for temperature differences and discrepancies in order to make components and/or any weaknesses visible, including:

- Thermal insulation and other types of insulation (e. g. locating thermal bridges)
- Active heating and hot water pipes (e. g. underfloor heating) in floors and walls
- Overheated electrical components (e. g. fuses or terminals)
- Machine parts (e. g. overheating due to faulty ball bearings)

The measuring tool must not be used for temperature measurement on persons and animals or for other medical purposes.

The measuring tool is not suitable for surface temperature measurement of gases or liquids.

Product Features

The numbering of the product features shown refers to the illustration of the measuring tool on the graphic page.

- 1 Protective cap for visual camera and infrared sensor
- 2 Serial number
- 3 Cover, micro USB port
- 4 Micro USB port
- 5 Up arrow button
- 6 "Func" measuring functions button
- 7 Switching temperature scale between automatic and fixed/right-hand function button
- 8 Right-hand arrow button
- 9 On/Off button
- 10 Down arrow button
- 11 Save button
- 12 Left-hand arrow button
- 13 Gallery button/left-hand function button
- 14 Display
- 15 Visual camera
- 16 Infrared sensor area
- 17 Freeze measurement/continue measuring button
- 18 Battery port

- 19 Release button for battery pack/battery adapter
- 20 Battery adapter sealing cap*
- 21 AA battery adapter cover*
- 22 Cover recess
- 23 Battery pack*
- 24 Micro USB cable
- 25 Protective pouch*

*The accessories illustrated or described are not included as standard delivery.

Display Elements

- a Date/time
- b Measuring function
- c Emissivity display
- d Indicator for *Bluetooth*[®] connection
- e WiFi switched on/off indicator
- f Charge-control indicator
- g Display of maximum surface temperature in the measurement range
- h Scale
- i Display of minimum surface temperature in the measurement range
- j Scale lock symbol
- k Hotspot display (example)
- l Crosshairs with temperature display
- m Coldspot display (example)
- n Gallery symbol

Technical Data

Thermal imaging camera	GTC 400 C
Article number	3 601 K83 1..
Resolution of infrared sensor	160 x 120
Thermal sensitivity	< 50 mK
Spectral range	8–14 µm
Field of view (FOV)	53 x 43°
Focus distance	≥ 0.3 m
Focus	Fixed
Surface temperature measurement range	-10... +400 °C
Measuring accuracy (typical)	
Surface temperature¹⁾	
-10... +10 °C	±3 °C
10...100 °C	±3 °C
> +100 °C	±3 %
Display type	TFT
Display size	3.5"
Display resolution	320 x 240
Image format	.jpg
Images saved per saving process	1 x thermal image (screenshot) 1 x real visual image incl. temperature values (metadata)

The measuring tool can be clearly identified with the serial number **2** on the type plate.

1) at an ambient temperature of 20–23 °C and an emissivity of >0.999, measuring distance: 0.3 m, operating time: >5 min

2) limited performance at temperatures <0 °C

Technical data determined with battery from delivery scope.

8 | English

Thermal imaging camera	GTC 400 C
Number of images in internal image memory (typical)	500
Integrated visual camera	●
Batteries (alkali-manganese)	4 x 1.5 V LR6 (AA) (with battery adapter)
Battery pack (lithium-ion)	10.8 V/12 V
USB port	1.1
TrackMyTools Bluetooth® module power supply	
– Button cell	CR2450 (3 V lithium battery)
– Battery service life, approx.	60 months
Bluetooth®	Bluetooth® 4.2 (Low Energy)
Max. Bluetooth® transmission power	3.2 mW
Frequency band Bluetooth®	2.402 – 2.480 GHz
Wireless connectivity	WiFi
Max. WiFi transmission power	30 mW
WiFi operating frequency range	2.400 – 2.483 GHz
Weight according to EPTA-Procedure 01:2014	0.54 kg
Dimensions (length x width x height)	233 x 95 x 63 mm
Degree of protection (excluding battery compartment)	IP 53
Permitted environmental conditions	
– Charging temperature	0 ... +45 °C
– Operating temperature ²⁾	–10 ... +45 °C
– Storage temperature	–20 ... +70 °C
– Relative humidity (non-condensing)	20 ... 80 %
Recommended batteries	GBA 10,8 V GBA 12 V
Recommended chargers	AL 11.. CV GAL 12.. CV

The measuring tool can be clearly identified with the serial number **2** on the type plate.

1) at an ambient temperature of 20–23 °C and an emissivity of >0.999, measuring distance: 0.3 m, operating time: >5 min

2) limited performance at temperatures <0 °C

Technical data determined with battery from delivery scope.

Assembly

Power Supply

The measuring tool can be operated using either commercially available batteries (LR6 AA batteries or similar) or using a Bosch Li-ion rechargeable battery.

Operation with Battery Adapter (Removable) (see figure A)

The batteries are inserted into the battery adapter.

► **The non-rechargeable battery adapter is intended only for use in designated Bosch measuring tools and must not be used with power tools.**

To **insert** the batteries, slide the cover of the battery adapter **21** into the battery port **18**. Place the batteries in the cover as per the illustration on the sealing cap **20**. Slide the sealing cap over the cover until you feel it click into place and it is flush with the handle of the measuring tool.



To **remove** the batteries, press the release buttons **19** of the sealing cap **20** and pull off the sealing cap. In doing so, make sure that the batteries do not fall out. To do this, hold the measuring tool with the battery port **18** facing upwards. Remove the batteries. To remove the inside cover **21** from the battery port **18**, reach into the cover recess **22** and pull it out of the measuring tool by applying light pressure to the side wall (see figure B).

Note: Do not use any tools (e.g. a screwdriver) to remove the battery, as this could break the casing.

Always replace all batteries at the same time. Only use batteries from one brand and with the identical capacity.

► **Remove the batteries from the measuring tool when not using it for extended periods.** When storing for extended periods, the batteries can corrode and self-discharge.

Operation with Battery Pack (see figure C)

Note: Use of battery packs not suitable for the measuring tool can lead to malfunctions or cause damage to the measuring tool.

Note: The battery pack is supplied partially charged. To ensure full capacity of the battery pack, completely charge the battery pack in the battery charger before using for the first time.

▶ **Use only the chargers listed in the technical data.** Only these battery chargers are matched to the lithium-ion battery of your measuring tool.

The lithium-ion battery pack can be charged at any time without reducing its service life. Interrupting the charging procedure does not damage the battery pack.





▶ **Following the automatic shut off of the measuring tool, do not continue to press the On/Off button.** The battery can be damaged.

To **insert** the charged battery pack **23**, slide it into the battery port **18** until you feel it engage and it is flush with the handle of the measuring tool.

To **remove** the battery pack **23**, press the unlocking buttons **19** and pull the battery pack out of the battery port **18**. **Do not use force to do this.**

Battery Status Indicator

The battery status indicator **f** on the display shows the charging state of the batteries or battery pack **23**.

Indication	Capacity
	> 2/3
	≤ 2/3
	≤ 1/3
	≤ 10 %
	Changing the Batteries or Battery Pack

Operation

▶ **Protect the measuring tool against moisture and direct sun light.**

▶ **Do not subject the measuring tool to extreme temperatures or variations in temperature.** As an example, do not leave it in vehicles for a long time. In case of large variations in temperature, allow the measuring tool to adjust to the ambient temperature before putting it into operation. In case of extreme temperatures or variations in temperature, the accuracy of the measuring tool can be impaired.

▶ **Make sure that the measuring tool is correctly acclimatised.** In the event of severe temperature fluctuations or environmental conditions which vary to a large degree, the measurement accuracy of the measuring tool may be impaired until it is fully acclimatised again.

▶ **Avoid hard knocks to the measuring tool or dropping it.** After severe external influences and in the event of abnormalities in the functionality, you should have the measuring tool checked by an authorised Bosch after-sales service agent.

Initial Operation

Switching On and Off

To take a measurement, fold the protective cap **1** upwards.

Make sure that the infrared measuring area is not closed off or covered while working.

To **switch on** the measuring tool, press the On/Off button **9**. A start sequence will appear in the display **14**. After the start sequence, the measuring tool will immediately begin to measure and will measure continuously until it is switched off.

Note: In the first few minutes, the measuring tool may self-calibrate several times, as the sensor temperature and ambient temperature have not yet been brought into line. Performing calibration again enables precise measurement. The thermal image freezes briefly during calibration.

To **switch off** the measuring tool, press the On/Off button again. The measuring tool saves all settings and then switches itself off. Close the protective cap **1** to transport the measuring tool safely.

In the "Settings" menu, you can choose whether and after how much time the measuring tool automatically switches off (see "Switch-off time", page 12).

If the battery or the measuring tool is not within the operating temperature range stated in the Technical Data, the measuring tool will shut down automatically after a brief warning (see "Troubleshooting – Causes and Corrective Measures", page 13). Allow the measuring tool to reach to the correct temperature and then switch it back on.

Preparing for Measurement

Setting the Emissivity Degree for Surface-temperature Measurements

The emissivity degree of an object depends on the material and the structure of its surface. It indicates whether an object (in comparison with other objects with the same temperature) emits much or little infrared heat radiation.

To determine the surface temperature, the tool performs a contactless measurement of the natural infrared thermal radiation emitted by the object at which the tool is aimed. To ensure correct measurement, the emissivity setting on the measuring tool must be checked **before every measurement** and adapted to the measuring object if necessary.

You can select one of the preset emissivity levels or enter an exact numerical value. Adjust the required emissivity using the "Measurement" > "Emissivity" menu (see page 11).

▶ **Temperature measurements will only be correct if the emissivity setting and the emissivity of the object match.**

Differences in colour may be caused by different temperatures and/or different emissivity levels. If the emissivity levels are very different, the depicted temperature differences may differ considerably from the actual temperature differences.

If there are multiple objects made of different materials or that have different structures in the measurement range, the displayed temperature values are only conclusive for the objects that match the emissivity setting. For all other objects

10 | English

(with different emissivity levels), the displayed colour differences can be used as an indication of temperature relationships.

Material	Emissivity (reference value 0 °C to 100 °C)
Concrete	0.93
Plaster/mortar	0.93
Roofing tiles	0.93
Roofing felt	0.93
Radiator paint	0.93
Wood	0.91
Linoleum	0.88
Paper	0.89

Notes on the Measuring Conditions

Highly reflective or shiny surfaces (e.g. shiny tiles or polished metals) may distort or impair the results shown. If necessary, mask the surface to be measured with a dark, matt adhesive tape that conducts heat well. Allow the tape to acclimatise briefly on the surface.

Make sure that a favourable measuring angle is used on reflective surfaces in order to ensure that the thermal radiation reflected by other objects does not distort the result. For example, the reflection of your own body heat may interfere with the measurement when measuring head-on from a perpendicular position. On a level surface, the outline and temperature of your body could therefore be displayed (reflected value), and these values do not correspond to the actual temperature of the measured surface (emitted value or real value of the surface).

Measuring through transparent materials (e.g. glass or transparent plastics) is fundamentally not possible.

The accuracy and reliability of the measuring results increase with better and more stable measuring conditions.

Infrared temperature measurement is impaired by smoke, vapour/high air humidity or dusty air.

Information for achieving improved measurement accuracy:

- Get as close as possible to the measuring object to minimise interfering factors between you and the surface to be measured.
- Ventilate indoor areas prior to measurement, especially when the air is contaminated or extremely steamy. After ventilating, allow the room to acclimatize for a while until the usual temperature has been reached again.

Assigning temperatures on the basis of the scale

A scale is shown on the right-hand side of the display. The values at the top and bottom end are oriented to the maximum and minimum temperature recorded in the thermal image. Colours are assigned to temperature values with a uniform distribution in the image (linearly).

Different shades can therefore be used to assign temperatures within these two limit values. For example, a temperature that is exactly between the maximum and minimum value can be assigned to the centre colour range of the scale.

To determine the temperature of a specific area, move the measuring tool so that the crosshairs with temperature display **I** are aimed at the required point or area.

In the automatic setting, the colour spectrum of the scale is always distributed linearly (= uniformly) across the entire measurement range between the maximum and minimum temperatures.

The thermal imaging camera displays all measured temperatures in the measurement range in relation to one another. If heat is displayed as blue in the colour palette in an area, for example in a colour representation, this means that the blue areas are among the colder measured values in the current measurement range. However, these areas may be in a temperature range that could cause injuries in certain circumstances. You should therefore always note the temperatures displayed on the scale or at the crosshairs themselves.



Functions

Adjusting the colour display

Depending on the measurement conditions, different colour palettes can make it easier to analyse the thermal image and show objects or circumstances more clearly in the display. This does not affect the measured temperatures. Only the way in which the temperature values are shown changes.

To change the colour palette, remain in measuring mode and press the right-hand **8** or left-hand **12** arrow button.

Superimposition of thermal image and real image

For improved orientation (= local assignment of the thermal image displayed), with matched temperature ranges, a visual real image can additionally be inserted.

Note: The superimposition of the real image and thermal image is accurate at a distance of 0.55 m. If the tool is closer to or further away from the object being measured, this may result in misalignment of the real image and thermal image.

The thermal imaging camera offers you the following options:

- **Complete infrared image**
Only the thermal image is displayed.
- **Image in image**
The thermal image displayed is cropped and the surrounding area is shown as a real image. This setting improves the local assignment of the measurement range.

– Transparency

The thermal image displayed is placed on top of the real image in such a way that it is slightly transparent. This enables improved detection of objects.

You can adjust the setting by pressing the up **5** or down **10** arrow buttons.

Fixing the scale

The colour distribution in the thermal image is adjusted automatically but can be fixed by pressing the right-hand function button **7**. This enables a comparison to be made between thermal images taken under different temperature conditions (e.g. when checking several rooms for thermal bridges).

To switch the scale back to automatic, press the right-hand function button **7** again. The temperatures are now dynamic again and adapt to the measured minimum and maximum values.

Measuring functions

To call up further functions which may be helpful for the display, press the **“Func”** button **6**. Use the right-hand/left-hand buttons to navigate through the displayed options to select a function. Select a function and press the **“Func”** button **6** again.

The following measuring functions are available:

- **“Automatic”**
Colours are distributed automatically in the thermal image
- **“Heat detector”**
Only the warmer temperatures in the measurement range are displayed as a thermal image in this measuring function. The area outside these warmer temperatures is displayed in greyscale as a real image so that coloured objects are not wrongly associated with temperatures (e.g. red cable in the control cabinet when looking for overheated components). Adjust the scale using the up **5** and down **10** buttons. This expands or reduces the temperature range shown.
The tool continues to measure minimum and maximum temperatures and displays these at the ends of the scale. You can, however, control which temperature range is shown in colour as a thermal image.
- **“Cold detector”**
Only the colder temperatures in the measurement range are displayed as a thermal image in this measuring function. The area outside these colder temperatures is displayed in greyscale as a real image so that coloured objects are not wrongly associated with temperatures (e.g. blue window frame when looking for faulty insulation). Adjust the scale using the up **5** and down **10** buttons. This expands or reduces the temperature range shown.
The tool continues to measure minimum and maximum temperatures and displays these at the ends of the scale. You can, however, control which temperature range is shown in colour as a thermal image.
- **“Manual”**
If greatly deviating temperatures are measured in the thermal image (e.g. radiator as a hot object when searching for thermal bridges), the available colours are distributed among a large number of temperature values in the range between the maximum and the minimum temperature.

This can result in a situation where subtle temperature differences can no longer be shown in detail. To obtain a detailed depiction of the focus temperature, switch to **“Manual”** mode and set the maximum and the minimum temperature. Doing this enables you to set the temperature range that is relevant to you and in which you would like to detect subtle differences. The **Reset** setting automatically readjusts the scale to the measured values in the infrared sensor's field of view.

Main Menu

To access the main menu, press the **“Func”** button **6** to call up the measuring functions. Now press the right-hand function button **7**.

- **“Measurement”**
 - **“Emissivity” c:**
A selection of saved emissivity levels is available for some of the most common materials. Select the appropriate material in the **“Material”** menu item. The corresponding emissivity is displayed in the line below. If you know the exact emissivity of the object to be measured, you can also set it as a numerical value in the **“Emissivity”** menu item.
 - **“Reflected temperature”:**
Setting this parameter improves the accuracy of measuring results, especially with low-emissivity (= high-reflection) materials. The reflected temperature normally corresponds to the ambient temperature. If there are objects with greatly deviating temperatures close to highly reflective objects which could affect the measurement, this value should be adjusted.
- **“Display”**
 - **“Hotspot” k: “ON/OFF”**
In this function, the hottest point (= measuring pixel) in the measurement range is automatically highlighted by red crosshairs in the thermal image. This can help you to detect a critical point, e.g. to locate a loose terminal in the control cabinet.
 - **“Cold spot” m: “ON/OFF”**
The coldest point (= measuring pixel) in the measurement range is automatically highlighted by blue crosshairs in the thermal image. This can help you to detect a critical point, e.g. to locate a leak in insulation.
 - **“Crosshairs” l: “ON/OFF”**
The crosshairs are displayed in the centre of the thermal image and show you the measured temperature value at this point.
 - **“Scale” h: “ON/OFF”**
- **“WiFi”: “ON/OFF”**
(see “Data Transmission”, page 12)
- **“Track My Tools”: “ON/OFF”**
(see “TrackMyTools”, page 14)
- **“Tool”**
 - **“Language”**
Under this menu item, you can change the language for all displays.

12 | English

– **“Time & Date” a**

To change the date and time in the display, open the **“Time & Date”** submenu. In this submenu you can also change the date and time format.

To exit the **“Time & Date”** submenu, press either the left-hand function button **13** under the tick symbol to save the settings or the right-hand function button **7** under the cross symbol to discard the changes.

– **“Audio signals”: “ON/OFF”**

Under this menu item, you can switch the audio signals on or off.

– **“Switch-off time”**

Under this menu item, you can select the time interval after which the measuring tool will automatically switch off if no buttons are pressed. You can also deactivate the automatic switch-off by selecting the **“Never”** setting.

– **“Delete all images”**

Under this menu item, you can delete all the files in the internal memory at once. Press the right-hand arrow button **8** for **“more ...”** to enter the submenu. Then press either the left-hand function button **13** under the tick symbol to delete all files, or the right-hand function button **7** under the cross symbol to cancel the operation.

– **“Tool information”**

Under this menu item, you can access information about the measuring tool. There you can find the serial number of the measuring tool and the installed software version.

You can also press button **17** to exit any menu and return to the standard display screen.

Documenting measurements

Saving measurements

The measuring tool begins to take measurements as soon as it is switched on and does so continuously until it is switched off.

To save an image, point the camera at the desired measuring object and press the **“Save”** button **11**. The image is saved in the camera’s internal memory. Alternatively, press the **“Freeze measurement”** button **17**. The measurement is frozen and shown in the display. This enables you to take as much time as you need to look at the image. If you do not wish to save the frozen image, press button **17** to return to measuring mode. If you wish to save the image in the camera’s internal memory, press the **“Save”** button **11**.

Calling up saved images

Proceed as follows to call up saved thermal images:

- Press the left-hand function button **13**. The most recently saved photo now appears in the display.
- Press the right-hand **8** or left-hand **12** arrow button to switch between the saved thermal images.

Deleting saved images

Go to the gallery view to delete individual thermal images:

- Press the right-hand function button **7** under the waste paper basket symbol.
- Confirm the operation by pressing the left-hand function button **13** or terminate the deletion process by pressing the right-hand function button **7** under the cancel symbol.

Delete all images

In the **“Delete all images”** menu, you can delete all the files in the internal memory at once.

Press the **“Func”** **6** button to call up the measuring functions. Now press the right-hand function button **7** and select **“Tool”** > **“Delete all images”**. Press the right-hand arrow button **8** to enter the submenu. Then press either the left-hand function button **13** under the tick symbol to delete all files, or the right-hand function button **7** under the cross symbol to cancel the operation.

Data Transmission

Data Transmission via USB Interface

Open the cover on the micro USB port **3**. Connect the micro USB port on the measuring tool to your PC or laptop using the micro USB cable provided.

Now press button **9** to switch on the thermal imaging camera.

Open the file browser and select the **“BOSCH GTC 400 C”** drive. The saved JPG files can be copied, moved to your computer or deleted from the internal memory of the measuring tool.

As soon as you have ended the required operation, disconnect the drive following the standard procedure and then use button **9** to switch the thermal imaging camera off again.

Remove the micro USB cable during the measurement operation and close the cover **3**.

Attention: Always disconnect the drive from your operating system first (eject drive), as failure to do so may damage the thermal imaging camera’s internal memory.

Always keep the cover of the USB interface closed so that dust and splashes cannot enter the housing.

Note: Only connect the measuring tool to a PC or notebook. The tool could be damaged if you connect it to a different device.

Note: The micro USB interface can only be used for data transmission – it is not suitable for charging batteries.

Post-editing the thermal images

You can post-edit the saved thermal images on your computer if it uses a Windows operating system. To do so, download the GTC Transfer software from the product page for the thermal imaging camera at

www.bosch-professional.com/gtc.

Data transmission via WiFi

The measuring tool is equipped with a WiFi module which enables the saved images to be wirelessly transmitted from your thermal imaging camera to a mobile device.

The **“Measuring Master”** application (app) is required as the software interface for this. You can download this from the store for your end device type:









In addition to wirelessly transmitting your images, the **“Measuring Master”** application makes it possible for you to use an extended range of functions and facilitates post-editing and forwarding of measured data (for example via e-mail). Information about system requirements for a WiFi connection can be found on the Bosch website at **“www.bosch-professional.com/gtc”**.

To activate or deactivate the WiFi connection on the measuring tool, call up the main menu, use the buttons to select **“WiFi”** and activate or deactivate it. **e** will appear on the display. Ensure that the WiFi interface is activated on your mobile device.

The connection between the mobile device and the measuring tool can be established after the Bosch application has been started (if WiFi modules are activated). To do this, follow the instructions in the **“Measuring Master”** application.

Troubleshooting – Causes and Corrective Measures

In the event of a fault, the tool will restart and can then continue to be used. If the fault persists, the following overview may help you.

Error	Cause	Corrective Measure
Measuring tool cannot be switched on.	Battery pack or batteries empty	Charge the battery pack or change the batteries.
	Battery too warm or too cold	Allow the battery to reach the correct temperature or change it.
	Measuring tool too warm or too cold	Allow the measuring tool to reach the correct temperature.
	Image memory defective	Format the internal memory by deleting all images (see “Delete all images”, page 12). If the problem persists, send the measuring tool to an authorised Bosch after-sales service agent.
	Image memory full	If required, transfer the images to another storage medium (e.g. computer or notebook). Then delete the images in the internal memory.
	Measuring tool is defective.	Send the measuring tool to an authorised Bosch after-sales service agent.
Measuring tool cannot be connected to a computer.	Measuring tool not recognised by computer.	Check whether the driver on your computer is up to date. It may be necessary to have a newer operating system version on your computer.
	Micro USB connection or micro USB cable defective	Check whether the measuring tool can be connected to a different computer. If not, send the measuring tool to an authorised Bosch after-sales service agent.

Definitions

Infrared heat radiation

Infrared heat radiation is electromagnetic radiation emitted by every body. The amount of radiation depends on the temperature and the emissivity degree of the body.

Emissivity Degree

The emissivity degree of an object depends on the material and the structure of its surface. It states how much infrared heat radiation the object emits compared to an ideal heat emitter (black body, emissivity degree $\epsilon = 1$).

Thermal Bridge

A thermal bridge is an object that undesirably transmits heat outwards or inwards, therefore differing significantly from the temperature of the rest of a wall or from the desired temperature of a wall.

As the surface temperature at thermal bridges is lower than in the rest of the room, the risk of mould increases significantly at these locations.

Reflected temperature/reflectivity of an object

The reflected temperature is the thermal radiation that is not emitted by the object itself. Depending on the structure and material, background radiation is reflected in the object to be measured, therefore distorting the actual temperature result.

14 | English**Distance from the object**

The distance between the object being measured and the measuring tool influences the captured area size per pixel. You can capture increasingly large objects as the distance from the object becomes greater.

Distance (m)	Size of infrared pixels (mm)	Infrared range width x height (m)
0.5	3	~ 0.5 x 0.4
1	6	~ 1 x 0.75
2	12	2.05 x 1.5
5	30	5.1 x 3.8

TrackMyTools

The built-in *Bluetooth*® Low Energy Module enables you to personalise and check the status of your measuring tool, as well as transfer settings and data using *Bluetooth*® wireless technology.

TrackMyTools *Bluetooth*® module power supply

The measuring tool is fitted with a button cell so that it can still be detected by a mobile device using TrackMyTools without having a battery pack **23** or batteries inserted.

You can find further information directly in the app from Bosch.

Data Transmission

You can switch the TrackMyTools *Bluetooth*® module on and off in the tool settings. It then emits a continuous signal.

The transmission interval of the module is eight seconds. Depending on ambient conditions, up to three transmission intervals may be required before the measuring tool is detected.

Note: Switch TrackMyTools off in areas where the transmission of radio waves is prohibited, for example on aeroplanes.

Registering and setting up the app/web-based application

Before you can use TrackMyTools, you need to register online.

To do this, open the website www.bosch-trackmytools.com and register. After registration is complete, you will receive your access information.

Download the app **TrackMyTools** from the relevant app store (Apple App Store, Google Play Store) or access the web application at <https://web.bosch-trackmytools.com>, where you can log in using your access details.

You can now create and manage your inventory using the app/web-based application.

Note: First, complete the tutorial for the app/web-based application. This will provide you with a better overview of the procedure for creating the inventory and using the software.

Maintenance and Service**Maintenance and Cleaning**

Store and transport the measuring tool only in a suitable container such as the original packaging or the protective pouch (accessory). Do not affix any stickers near to the infrared sensor on the measuring tool.

Keep the measuring tool clean at all times.

When cleaning, fluids should not penetrate into the measuring tool.

Do not attempt to remove dirt from the sensor, camera or reception lens using pointed objects, and do not wipe over the camera and reception lens (risk of scratching).

If you would like your measuring tool to be recalibrated, please contact a Bosch service centre (for addresses, see section "After-sales Service and Application Service").

If the event of a repair, send in the measuring tool in the original packaging or in the protective pouch (accessory).

The integrated button cell may only be removed for disposal by qualified personnel. Opening the housing shell can destroy the measuring tool. Unscrew the screws on the housing and remove the housing shell in order to remove the button cell.

After-sales Service and Application Service

Our after-sales service responds to your questions concerning maintenance and repair of your product as well as spare parts. Exploded views and information on spare parts can also be found under:

www.bosch-pt.com

Bosch's application service team will gladly answer questions concerning our products and their accessories.

In all correspondence and spare parts orders, please always include the 10-digit article number given on the nameplate of the product.

Cambodia

Robert Bosch (Cambodia) Co., Ltd
Unit 8BC, GT Tower, 08th Floor, Street 169,
Czechoslovakia Blvd, Sangkat Veal Vong
Khan 7 Makara, Phnom Penh
VAT TIN: 100 169 511
Tel.: +855 23 900 685
Tel.: +855 23 900 660
www.bosch.com.kh

People's Republic of China

China Mainland
Bosch Power Tools (China) Co., Ltd.
567, Bin Kang Road
Bin Jiang District 310052
Hangzhou, P. R. China
Tel.: 4008268484
Fax: (0571) 87774502
E-Mail: contact.ptcn@cn.bosch.com
www.bosch-pt.com.cn

HK and Macau Special Administrative Regions

Robert Bosch Co. Ltd.
21st Floor, 625 King's Road
North Point, Hong Kong
Customer Service Hotline: +852 2101 0235
Fax: +852 2590 9762
E-Mail: info@hk.bosch.com
www.bosch-pt.com.hk

India

Bosch Service Center
69, Habibullah Road, (Next to PSBB School), T. Nagar
Chennai – 600077
Phone: (044) 64561816

Bosch Service Center Rishyamook
85A, Panchkuin Road
New Delhi – 110001
Phone: (011) 43166190

Bosch Service Center
79, Crystal Bldg., Dr. Annie Besant Road, Worli
Mumbai – 400018
Phone: (022) 39569936 / (022) 39569959 /
(022) 39569967 / (022) 24952071

Indonesia

PT Robert Bosch
Palma Tower 10th Floor
Jalan RA Kartini II-S Kaveling 6
Pondok Pinang, Kebayoran Lama
Jakarta Selatan 12310
Tel.: (21) 3005-5800
www.bosch-pt.co.id

Malaysia

Robert Bosch Sdn. Bhd. (220975-V) PT/SMY
No. 8A, Jalan 13/6
46200 Petaling Jaya
Selangor
Tel.: (03) 79663194
Toll-Free: 1800 880188
Fax: (03) 79583838
E-Mail: kiathoe.chong@my.bosch.com
www.bosch-pt.com.my

Pakistan

Robert Bosch Middle East FZE – Pakistan Liaison Office
2nd Floor Plaza # 10, CCA Block, DHA Phase 5
Lahore, 54810
Phone: +92(303)4444311
Email: Faisal.Khan@bosch.com

Philippines

Robert Bosch, Inc.
28th Floor Fort Legend Towers,
3rd Avenue corner 31st Street,
Fort Bonifacio, Global City,
1634 Taguig City
Tel.: (632) 8703871
Fax: (632) 8703870
www.bosch-pt.com.ph

Singapore

Powerwell Service Centre Ptd Ltd
Bosch Authorised Service Centre (Power Tools)
4012 Ang Mo Kio Ave 10, #01-02 TECHplace
Singapore 569628
Tel.: 6452 1770
Fax: 6452 1760
E-Mail: ask@powerwellsc.com
www.powerwellsc.com
www.bosch-pt.com.sg

Thailand

Robert Bosch Ltd.
Liberty Square Building
No. 287, 11 Floor
Silom Road, Bangrak
Bangkok 10500
Tel.: 02 6393111
Fax: 02 2384783
Robert Bosch Ltd., P. O. Box 2054
Bangkok 10501
www.bosch.co.th

Bosch Service – Training Centre
La Salle Tower Ground Floor Unit No.2
10/11 La Salle Moo 16
Srinakharin Road
Bangkaew, Bang Plee
Samutprakarn 10540
Tel.: 02 7587555
Fax: 02 7587525

Vietnam

Branch of Bosch Vietnam Co., Ltd in HCMC
Floor 10, 194 Golden Building
473 Dien Bien Phu Street
Ward 25, Binh Thanh District, Ho Chi Minh City
Tel.: (08) 6258 3690
Fax: (08) 6258 3692
Hotline: (08) 6250 8555
www.bosch-pt.com.vn

Armenia, Azerbaijan, Georgia, Kyrgyzstan, Mongolia, Tajikistan, Turkmenistan, Uzbekistan

TOO "Robert Bosch" Power Tools, After Sales Service
Rayimbek Ave., 169/1
050050, Almaty, Kazakhstan
Service Email: service.pt.ka@bosch.com
Official Website: www.bosch.com, www.bosch-pt.com

Bahrain

Hatem Al Juffali Technical Equipment Establishment.
Kingdom of Bahrain, Setra Highway, Al Aker Area
Phone: +966126971777-311
Fax: +97317704257
Email: h.berjas@ejab.com.sa

Egypt

Unimar
20 Markaz kadmat
El tagmoa EL Aoul – New Cairo
Phone: + 20 2224 76091-95
Phone: + 20 2224 78072-73
Fax: + 20 2224 78075
Email: adelzaki@unimaregypt.com

Iran

Robert Bosch Iran
3rd Floor, No 3, Maadiran Building
Aftab St., Khodami St., Vanak Sq.
Tehran 1994834571
Phone: +9821- 86092057

16 | English**Iraq**

Sahba Technology Group
 Al Muthana airport road
 Baghdad
 Phone: +9647901906953
 Phone Dubai: +97143973851
 Email: bosch@sahbatechnology.com

Jordan

Roots Arabia – Jordan
 Nasser Bin Jameel street, Building 37 Al Rabiah
 11194 Amman
 Phone: +962 6 5545778
 Email: bosch@rootsjordan.com

Kuwait

Al Qurain Automotive Trading Company
 Shuwaikh Industrial Area, Block 1, Plot 16, Street 3rd
 P.O. Box 164 – Safat 13002
 Phone: 24810844
 Fax: 24810879
 E-mail: josephkr@aaalmutawa.com

Lebanon

Tehini Hana & Co. S.A.R.L.
 P.O. Box 90-449
 Jdeideh
 Dora-Beirut
 Phone: +9611255211
 Email: service-pt@tehini-hana.com

Libya

El Naser for Workshop Tools
 Swanee Road, Alfalah Area
 Tripoli
 Phone: +218 21 4811184

Oman

Malatan Trading & Contracting LLC
 P.O. Box 131
 Ruwi, 112 Sultanate of Oman
 Phone: +968 99886794
 Email: malatanpowertools@malatan.net

Qatar

International Construction Solutions W L L
 P. O. Box 51, Doha
 Phone: +974 40065458
 Fax: +974 4453 8585
 Email: csd@icsdoha.com

Saudi Arabia

Juffali Technical Equipment Co. (JTECO)
 Kilo 14, Madinah Road, Al Bawadi District
 Jeddah 21431
 Phone: +966 2 6672222 Ext. 1528
 Fax: +966 2 6676308
 Email: roland@ejb.com.sa

Syria

Dallal Establishment for Power Tools
 P.O. Box 1030
 Aleppo
 Phone: +963212116083
 Email: rita.dallal@hotmail.com

United Arab Emirates

Central Motors & Equipment LLC, P.O. Box 1984
 Al-Wahda Street – Old Sana Building
 Sharjah
 Phone: +971 6 593 2777
 Fax: +971 6 533 2269
 Email: powertools@centralmotors.ae

Yemen

Abualrejal Trading Corporation
 Sana'a Zubiery St. Front to new Parliament Building
 Phone: +967-1-202010
 Fax: +967-1-279029
 Email: tech-tools@abualrejal.com

Ethiopia

Forever plc
 Kebele 2,754, BP 4806,
 Addis Ababa
 Phone: +251 111 560 600
 Email: foreverplc@ethionet.et

Ghana

C. WOERMANN LTD.
 Nsawam Road/Avenor Junction, P.O. Box 1779
 Accra
 Phone: +233 302 225 141

Kenya

Robert Bosch East Africa Ltd
 Mpaka Road P.O. Box 856
 00606 Nairobi

Nigeria

Robert Bosch Nigeria Ltd.
 52 – 54 Isaac John Street P.O. Box
 GRA Ikeja – Lagos

Republic of South Africa

Customer service
 Hotline: (011) 6519600

Gauteng – BSC Service Centre

35 Roper Street, New Centre
 Johannesburg
 Tel.: (011) 4939375
 Fax: (011) 4930126
 E-Mail: bsctools@icon.co.za

KZN – BSC Service Centre

Unit E, Almar Centre
143 Crompton Street
Pinetown
Tel.: (031) 7012120
Fax: (031) 7012446
E-Mail: bsc.dur@za.bosch.com

Western Cape – BSC Service Centre

Democracy Way, Prosperity Park
Milnerton
Tel.: (021) 5512577
Fax: (021) 5513223
E-Mail: bsc@zsd.co.za

Bosch Headquarters

Midrand, Gauteng
Tel.: (011) 6519600
Fax: (011) 6519880
E-Mail: rbsa-hq.pts@za.bosch.com

Tanzania

Diesel & Autoelectric Service Ltd.
117 Nyerere Rd., P.O. Box 70839
Vingunguti 12109, Dar Es Salaam
Phone: +255 222 861 793/794

Australia, New Zealand and Pacific Islands

Robert Bosch Australia Pty. Ltd.
Power Tools
Locked Bag 66
Clayton South VIC 3169
Customer Contact Center
Inside Australia:
Phone: (01300) 307044
Fax: (01300) 307045
Inside New Zealand:
Phone: (0800) 543353
Fax: (0800) 428570
Outside AU and NZ:
Phone: +61 3 95415555
www.bosch-pt.com.au
www.bosch-pt.co.nz
Supplier code ERAC000385

Transport

The usable lithium-ion battery packs are subject to the Dangerous Goods Legislation requirements. The user can transport the battery packs by road without further requirements. When being transported by third parties (e.g. via air transport or forwarding agency), special requirements on packaging and labelling must be observed. For preparation of the item being shipped, consulting an expert for hazardous material is required.

Dispatch battery packs only when the housing is undamaged. Tape or mask off open contacts and pack up the battery pack in such a manner that it cannot move around in the packaging. Please also observe possibly more detailed national regulations.

Disposal

Measuring tools, battery packs/batteries, accessories and packaging should be sorted for environmental-friendly recycling.



Do not dispose of measuring tools and batteries/rechargeable batteries into household waste!

Battery packs/batteries:**Li-ion:**

Please observe the instructions in section "Transport", page 17.

Subject to change without notice.

中文**安全规章**

必须阅读并注意所有说明。如果不按照给出的说明使用测量仪，可能会影响集成在测量仪中的保护功能。请妥善保存这些说明。

- ▶ 本仪器只能交给合格的专业人员修理，而且只能使用原厂的备件。如此才能够确保仪器的安全性能。
- ▶ 不要在易爆环境，如有易燃液体、气体或粉尘的环境下操作测量仪器。测量仪器内可能产生火花并点燃粉尘和气体。
- ▶ 在测量仪上进行任何工作（例如安装、维护等）以及搬运、保存测量仪之前，都必须从设备中取出电池或蓄电池。
- ▶ 不可以打开蓄电池。有短路的危险。



蓄电池必须远离高温，蓄电池也要避开持续的日照、火焰、水和湿气。有爆炸的危险。



- ▶ 不使用的蓄电池要远离回纹针、硬币、钥匙、钉子、螺丝或其他可能桥接触点的小金属物体。蓄电池的触点如果产生短路，可能着火或造成火灾。
- ▶ 如果滥用蓄电池，可能从蓄电池中渗出液体。避免接触此液体。如果不小心碰触了要用水冲刷。万一该液体进入眼中必须尽快就医。从蓄电池渗出的液体可能刺激皮肤或灼伤皮肤。
- ▶ 损坏的和被滥用的蓄电池会冒出蒸气，因此要确保工作场所空气流通。身体如果出现任何不适得尽快就医。此蒸气可能刺激呼吸道。
- ▶ 只能使用制造厂商推荐的充电器为蓄电池充电。使用针对特定蓄电池的充电器替其他的蓄电池充电，可能会酿成火灾。

18 | 中文

- ▶ **本蓄电池只能安装在博世的测量仪器上使用。** 只有这样才能保护蓄电池，避免发生危险的过载情形。
- ▶ **钉子、螺丝刀等尖锐物品或外力作用可能会损坏电池。** 有可能出现内部短路并导致电池燃烧、冒烟、爆炸或过热。
- ▶ **电池适配器仅用于特定的博世测量仪，不允许配合电动工具使用。**
- ▶ **不使用测量仪时，必须从仪器中取出电池。** 长期搁置之后，电池会腐蚀或自行放电。
- ▶ **请保护好测量仪，尤其是摄像头和红外镜头部位，避免受到雨雪影响。** 接收镜头可能会蒙上雾气，使测量结果失真。错误的设备设置及其它环境影响因素可能会导致测量错误。显示的物体温度可能会较热或较冷，因而当触摸物体时可能会发生危险。
- ▶ **热成像中较高的温度差可能会导致即使温度较高也显示出与低温相关的颜色。** 触摸这类表面可能会导致烫伤！
- ▶ **只有当设置的辐射率和物体辐射率一致时，才能正确测量温度。** 显示的物体温度和 / 或颜色可能会较热或较冷，因而当触摸物体时可能会发生危险。
- ▶ **小心！在使用配有蓝牙®的测量仪时，其它装置和设备，飞机和医疗设备（例如心脏起搏器、助听器）可能发生故障。同样不能完全排除周围的人 and 动物会受到伤害。请不要在医疗设备，加油站，化工厂，有爆炸危险的地区附近和在爆破区内使用配有蓝牙®的测量仪。请不要在飞机上使用配有蓝牙®的测量仪。请避免在身体附近较长时间使用。**
- ▶ **本测量仪装备了一个无线接口。必须注意本地运行限制，例如在飞机上或医院里。**

产品和功率描述

蓝牙® 文字标记和图形符号（标志）是 Bluetooth SIG 公司的注册商标和财产。Robert Bosch Power Tools GmbH 有限公司根据许可使用这些文字标记 / 图形符号。

按照规定使用机器

本热成像摄像头用于以非接触方式测量表面温度。

显示的热成像显示了红外镜头探测区域的温度分布，因而能够用不同颜色区别显示温度偏差。

这样一来，在正确的使用条件下，本设备能无接触地分析表面和物体的温差或温度异常，使零部件和 / 或薄弱位置变得可见，例如：

- 隔热和保温层（例如找出热桥）
- 地板和墙壁中的主动导热管或热水管（例如地暖）
- 过热的电气部件，例如保险丝或端子
- 机械零件（例如因球轴承损坏引起的过热）

不允许使用本测量仪测量人体和动物的温度或用于其他医疗目的。

本测量仪不适用于测量气体或液体的表面温度。

插图上的机件

机件的编号和仪器详解图上的编号一致。

- 1 可视摄像头和红外传感器保护盖
- 2 序列号码
- 3 Micro USB 插口盖板
- 4 Micro USB 插口
- 5 向上箭头键
- 6 测量功能键 "Func"
- 7 切换温度刻度自动固定 / 右侧功能键
- 8 右向箭头键
- 9 起停开关
- 10 向下箭头键
- 11 保存键
- 12 左向箭头键
- 13 图库键 / 左侧功能键
- 14 显示屏
- 15 可视摄像头
- 16 红外传感器范围
- 17 冻结测量 / 继续测量键
- 18 蓄电池室
- 19 充电电池 / 电池适配器解锁按键
- 20 电池适配器密封帽*
- 21 电池适配器外壳*
- 22 外壳凹口
- 23 蓄电池*
- 24 Micro USB 电缆
- 25 保护套*

*图表或说明上提到的附件，并非包含在供货范围中。

显示图

- a 日期 / 时间
- b 测量功能
- c 辐射率显示
- d 蓝牙® 连接显示器
- e WiFi 接通 / 关闭显示
- f 电容量的显示灯号
- g 测量范围内表面最高温度显示
- h 刻度
- i 测量范围内表面最低温度显示
- j 刻度锁定图标
- k 热点显示（举例）
- l 带温度显示的十字线
- m 冷点显示（举例）
- n 图片集图标

技术数据

热成像摄像头	GTC 400 C
物品代码	3 601 K83 1..
红外线传感器分辨率	160 x 120
温度灵敏性	< 50 mK
自由光谱区	8 - 14 μ m
视野 (FOV)	53 x 43°
焦距	≥ 0.3 米
焦点	固定
表面温度测量范围	-10...+400 °C
测量精度 (一般)	
表面温度¹⁾	
-10...+10 °C	± 3 °C
10...100 °C	± 3 °C
> +100 °C	± 3 %
显示屏类型	TFT
显示屏尺寸	3.5"
显示屏解析度	320 x 240
图片格式	.jpg
每次存储过程的存储图片数量	1 张热成像 (截屏) 1 张虚拟实像, 包括温度值 (元数据)
内部图像存储器 (常规) 中的图像数目	500
内置虚拟摄像头	●
电池 (碱 - 锰)	4 x 1.5 伏特 LR6 (AA) (带电池适配器)
蓄电池 (锂离子)	10.8 伏特 / 12 伏特
USB 接头	1.1
能源供应 TrackMyTools 蓝牙® 模块	
- 纽扣电池	CR2450 (3V 锂电池)
- 电池使用寿命约为	60 月
蓝牙®	蓝牙® 4.2 (低功耗)
蓝牙® 最大发射功率	3.2 毫瓦
波段 蓝牙®	2.402 - 2.480 GHz
无线连接	WiFi
WiFi 最大发射功率	30 毫瓦
WiFi 工作频率范围	2.400 - 2.483 GHz
重量符合 EPTA-Procedure 01:2014	0.54 公斤
尺寸 (长 x 宽 x 高)	233 x 95 x 63 毫米
保护等级 (不包含电池盒)	IP 53

仪器铭牌上的序列号码 (仪器详解上标示着 **2** 的位置) 便是仪器的识别码。

1) 当环境温度为 20 - 23 °C 且辐射率 > 0.999 时, 测量距离为: 0.3 m, 工作时间: >5 min

2) 温度 < 0 °C 时功率受限

使用附带的蓄电池所测得的技术数据。

20 | 中文

热成像摄像头

GTC 400 C

允许的环境条件

- 充电温度

0...+45 °C

- 工作温度²⁾

-10...+45 °C

- 储藏温度范围

-20...+70 °C

- 相对湿度 (无冷凝)

20... 80 %

建议使用的充电电池

GBA 10,8 V

GBA 12 V

推荐的充电器

AL 11.. CV

GAL 12.. CV

仪器铭牌上的序列号码 (仪器详解上标示着 2 的位置) 便是仪器的识别码。

1) 当环境温度为 20 - 23 °C 且辐射率 > 0.999 时, 测量距离为: 0.3 m, 工作时间: >5 min

2) 温度 <0 °C 时功率受限

使用附带的蓄电池所测得的技术数据。

安装

供电

本测量仪可以使用市售电池 (AA 电池, 型号 LR6 或类似) 或博世锂离子充电电池运行。

含电池适配器的运行 (可拔出) (参考插图 A)

电池应装在电池适配器中。

▶ **电池适配器仅用于特定的博世测量仪, 不允许配合电动工具使用。**

要**装入**电池, 请将电池适配器 21 的外壳推入电池仓 18 中。根据密封帽 20 上的图示将电池放入外壳中。将密封帽推到外壳上方, 直至能感觉到它卡入且与测量仪手柄平齐。



要**取出**电池, 则按压密封帽 20 的解锁按键 19, 然后拔下密封帽。注意电池不要掉出。支撑住测量仪, 向上对准电池仓 18。取出电池。要从蓄电池仓 18 中取出位于内部的外壳 21, 请将手深入外壳的凹口 22 中, 然后轻轻按压侧壁将其从测量仪中取出 (参考插图 B)。

指示: 取出充电电池请勿使用工具 (例如螺丝起子机), 否则可能会折断外壳。

务必同时更换所有的电池。请使用同一制造厂商, 相同容量的电池。

▶ **不使用测量仪时, 必须从仪器中取出电池。** 长期搁置之后, 电池会腐蚀或自行放电。

以蓄电池驱动 (参考插图 C)

指示: 使用了不适合测量仪器的蓄电池可能造成测量仪器故障或损坏测量仪器。

指示: 蓄电池在供货时只完成了部分充电。为了确保它能够发挥最大的功效, 首度使用前得先以充电器替蓄电池充足电。

▶ **请只使用在技术参数中列出的充电器。** 只有这些充电器才与可用在本测量仪上的锂离子蓄电池相匹配。

您可以随时替锂离子蓄电池充电, 不必担心会缩短它的使用寿命。中断充电过程也不会损坏蓄电池。

▶ **探测仪自动关闭后请勿继续按压开关按键。** 否则可能会损坏电池。

要**装入**已充电的蓄电池 23, 请将该蓄电池推入蓄电池仓 18 中, 直至能感觉到它卡入且与测量仪手柄平齐。为**拆卸**充电电池 23, 请按压解锁按钮 19, 将充电电池从电池仓 18 中抽出。**在此过程中请勿过度用力。**

蓄电池充电电量指示灯

显示屏中的充电电量指示灯 f 显示电池或蓄电池 23 的充电电量。

显示图	容量
	> 2/3
	≤ 2/3
	≤ 1/3
	≤ 10 %
	更换电池或蓄电池

正式操作

▶ **不可以让湿气渗入仪器中, 也不可以让阳光直接照射在仪器上。**

▶ **仪器不可以暴露在极端的气候下, 也不可以把仪器放在温差相当大的环境中。** 仪器不可以长期放置在汽车中。如果仪器先后暴露在温差相当大的环境中, 必须先等待仪器温度恢复正常后再使用仪器。如果仪器暴露在极端的气候下或温差相当大的环境中, 会影响仪器的测量准确度。

▶ **注意测量仪正确的环境适应性。** 当出现温度剧烈波动或环境条件剧烈变化时, 测量仪的测量精度会持续受到影响, 直到它重新完全适应。

▶ **避免测量仪剧烈碰撞或掉落。** 在发生强烈的外界作用后以及功能异常时, 应将测量仪交由授权的博世售后服务点进行检查

正式操作仪器

开动 / 关闭

测量时打开保护盖 1。在工作中请注意不要封闭或遮挡红外测量范围。

要接通测量仪，请按压起停开关 9。在显示屏 14 中显示启动顺序。启动顺序结束后，测量仪立刻开始测量并自动连续运行直至关闭。

指示： 在最初几分钟内，测量仪可能会自动频繁调校，因为此时传感器温度和环境温度尚未完成匹配。重新校准后可以精确测量。热成像在校准期间会短时冻结。

如需关闭测量仪，请再次按压起停开关。测量仪保存所有设置，然后自动关闭。请合上保护盖 1，以确保安全运输测量仪。

您可以在设置菜单中选择是否以及多久之后自动关闭测量仪（参见“关闭时间”，第 23 页）。

如果蓄电池或测量仪超出技术参数中给出的工作温度，则测量仪在发出一个短促的警告（参见“故障—原因和处理措施”，第 24 页）后自动关闭。使测量仪调温，然后将其重新接通。

测量准备

为进行表面温度测量设置辐射率

物体辐射率取决于其表面的材质和结构。它说明了某个物体（与其它相同温度的物体相比）是否或多或少地发射红外热辐射。

要确定表面温度，请以非接触方式测量所显示物体发射出的天然红外热辐射。为了确保正确测量，必须在每次测量时检查测量仪上设置的辐射率，必要时与测量物体进行匹配。

您可以选择一个预设好的辐射率，或者输入一个具体的数值。请通过菜单“测量”>“辐射率”设置所需的辐射率（参见第 22 页）。

▶ **只有当设置的辐射率和物体辐射率一致时，才能正确测量温度。**

色差可能是由不同的温度和 / 或不同的辐射率导致的。如果辐射率差别较大，显示的温差会明显偏离实际温差。

如果测量范围内有不同材料或不同结构的多个测量物体，那么显示的温度值仅对与设定的辐射率相匹配的物体适用。对于所有其它（具有不同辐射率）物体，显示的色差可以用作温度关系提示。

物料	辐射率 (参考值 0 °C...100 °C)
混凝土	0.93
灰浆 / 砂浆	0.93
砖块	0.93
屋面油毡	0.93

物料	辐射率 (参考值 0 °C...100 °C)
散热器搪瓷	0.93
木材	0.91
油毡	0.88
纸张	0.89

测量条件提示

高反射或光泽表面（例如光泽的瓷砖或光亮的金属）可能影响显示的测量结果或导致其失真。必要时用导热良好的深色亚光胶带贴住测量面。让胶带短暂地在表面上调温。

对于反射表面请确保良好的测量角度，这样其它物体的反射热辐射不会使测量结果失真。例如，从前面垂直测量时，您自身的体热反射会影响测量。在测量平整表面时，这样会显示您的身体轮廓和体温（反射值），而非被测表面的本来温度（表面的测得值或实际值）。

原则上，无法穿过透明材料（例如玻璃或透明塑料）进行测量。

测量条件越好越稳定，测量结果就越确切可靠。

烟、蒸汽 / 高湿度或含有粉尘的空气将影响红外温度测量。

提高测量精度的提示：

- 请尽可能靠近测量物体，将您与测量表面之间的干扰因素降至最低。
 - 在测量前为室内通风，尤其是当空气较脏或有大量水汽时。
- 通风后使房间调温一会儿，直至重新达到常温。

根据刻度匹配温度

显示屏的右侧显示有一个刻度。上端和下端的数值对应于热成像中测得的最高或最低温度。热成像中颜色与温度值划分是均匀（线性）分配的。

因而可以利用不同的色调在这两个边界范围内分配温度。正好位于最高值和最低值中心的温度例如可以分配以刻度中间的颜色区域。

在测定具体范围的温度时，请移动测量仪，使带有温度显示的十字线 I 对准需要测量的点或范围。

在自动设置中，刻度的色谱总是线性（= 均匀）地分配在最高和最低温度之间的整个测量范围上。

热成像摄像头显示测量范围内所有测得的温度，相互之间成比例显示。如果在某个范围内，例如在某个彩色显示图内，调色板中的热量显示为淡蓝色，那么说明淡蓝色范围属于当前测量范围内温度相对较低的测量值。但是这些范围却可能处于一个可导致受伤的温度区域内。因此，请始终在刻度表上或直接于十字线上观察显示的温度。



功能

彩色显示的匹配

根据测量情况，不同的调色板可以方便热成像的分析，并清晰地显示屏上显示物体或实际情况。这不会影响测得的温度。它只改变温度值的显示。

切换调色板时，请停留在测量模式，按压向右箭头键 **8** 或向左箭头键 **12**。

热成像和真实图像重叠

为了更好地定位（= 所显示热成像的空间位置匹配），可以在调整好温度范围后另外叠加一张视觉真实图像。

指示： 真实图像和热成像的叠加在 0.55 m 的距离上最准确。如果与测量物体的距离存在偏差，可能会导致真实图像和热成像偏移。

热成像摄像头可以为您提供以下功能：

- **100 % 红外图像**
仅显示热成像。
- **画中画**
显示的热成像经过剪裁，四周区域显示真实图像。这一设置可优化测量范围的位置匹配。
- **透明度**
显示的热成像以略微透明的形式叠在真实图像上方。这样能够更好地识别物体。

通过按压向上箭头键 **5** 或向下箭头键 **10**，您可以调整设置。

固定刻度

热成像中的颜色分配是自动进行调整的，但是可以通过按压右侧功能键 **7** 进行冻结。这样就可以对不同温度条件下测得的热成像进行比较（例如在检测多个空间的热桥时）。

如需重新将刻度切换为自动，请再次按下右侧功能键 **7**。温度现在重新动态变化，根据测得的最高值和最低值进行调整。

测量功能

如需调用其它可在显示中提供帮助的功能，请按压按键 **"Func"** **6**。用向左 / 向右键在显示的选项中导航，以便选中一个功能。选择一个功能，然后再次按下按键 **"Func"** **6**。

有以下测量功能可用：

- **"自动"**
在热成像中自动进行颜色分配。
- **"热态搜索器"**
在该测量功能下只会把测量范围内较热的温度显示为热成像。这些较热温度以外的范围将显示为灰阶真实图像，以免将彩色物体错误地与温度联系起来（例如在查找过热的零部件时与电气柜内的红色电缆混淆）。用向上键 **5** 和向下键 **10** 调整刻度。这样可以放大或缩小显示的温度范围。

设备仍然同时测量最低和最高温度，并显示在刻度的两端。但是您可以控制哪个温度范围要作为热成像进行彩色显示。

- **"冷态查找器"**
在该测量功能下只会把测量范围内较冷的温度显示为热成像。这些较冷温度以外的范围将显示为灰阶真实图像，以免将彩色物体错误地与温度联系起来（例如在查找有问题的绝缘层时与蓝色窗框混淆）。用向上键 **5** 和向下键 **10** 调整刻度。这样可以放大或缩小显示的温度范围。
设备仍然同时测量最低和最高温度，并显示在刻度的两端。但是您可以控制哪个温度范围要作为热成像进行彩色显示。
- **"手动"**
如果热成像中测得的温差较大（例如在检查热桥时将散热器测为高温物体），那么可用的颜色将分布在最高和最低温度之间的众多温度值上。这可能会导致无法再详细地显示细微的温差。为了能够详尽地显示焦点温度，请按以下方式操作：在切换到 **"手动"** 模式后，您可以设置最高或最低温度。这样就可以设定与您相关的温度范围，从而能够识别细微的区别。在 **复位** 设置中，刻度又可以根据红外传感器视野范围内的测量值自动进行调整。

主菜单

如需进入主菜单，请按下按键 **"Func"** **6**，调出测量功能。现在按下右侧功能键 **7**。

- **"测量"**
 - **"辐射率" c:**
对于若干最常见材料，有已存储的辐射率可供选择。请在菜单项 **"材料"** 中选择相匹配的材料。相应辐射率显示在下面一行中。
如果您已知测量物体的确切辐射率，也可在菜单项 **"辐射率"** 中以数值形式设置该辐射率。
 - **"反射温度":**
这个参数的设置可以改善测量结果，特别是对于辐射率较低（= 高反射）的材料。反射的温度通常相当于环境温度。
如果反射强烈的物体附近有温差较大的物体会影响测量，那么应调整该数值。
- **"显示器"**
 - **"热点" k: "打开 / 关闭"**
该功能可以通过红色十字线在热成像中自动标注出测量范围内温度最高的点（= 测量像素）。这可以帮助您识别关键位置，例如电气柜内某个松动的端子。
 - **"冷点" m: "打开 / 关闭"**
自动为您蓝色的十字线在热成像中标注出测量范围内温度最低的点（= 测量像素）。这可以帮助您识别关键位置，例如隔热层中某个泄漏部位。
 - **"十字线" l: "打开 / 关闭"**
十字线显示在热成像中心，为您指示该位置上测得的温度值。
 - **"刻度" h: "打开 / 关闭"**

- "WiFi": "打开 / 关闭"

(参见 "数据传输", 第 23 页)

- "Track My Tools": "打开 / 关闭"

(参见 "TrackMyTools", 第 25 页)

- "设备"

- "语言"

您可以在该菜单项下调整所有显示的语言。

- "时间 / 日期" a

如需更改显示中的日期和时间, 请调出子菜单

"时间 / 日期"。此外, 在该子菜单中还可更改日期和时间格式。

要退出子菜单 "时间 / 日期", 可按压打勾图标下的左侧功能键 13, 以保存设置, 或者按压打叉图标下的右侧功能键 7, 以放弃修改。

- "信号音": "打开 / 关闭"

您可以在该菜单项下打开 / 关闭信号音。

- "关闭时间"

您可以在该菜单项中选择测量仪在不按压任何按键时自动关闭的时间间歇。选择设置 "切勿", 您也能停用自动关闭。

- "删除所有图像"

在该菜单项下可以一次性删除内部存储器中的所有文件。要进入子菜单, 按压向右箭头键 8 选中

"更多..."。然后或者按压打勾图标下的左侧功能键 13, 以删除所有文件, 或者按压打叉图标下的右侧功能键 7, 以取消这个过程。

- "设备信息"

您可以在该菜单项下调出关于测量仪的信息。您在这里可找到测量仪的序列号和安装的软件版本。

要退出任一菜单并返回标准显示屏, 您也可按压按键 17。

记录测量结果

保存测量结果

测量仪接通后立刻开始测量并连续运行直至关闭。

如需保存图像, 请将摄像头对准所需的测量物体, 然后按下保存键 11。图像将被保存在摄像头的内部存储器中。也可以按下冻结测量键 17。测量被冻结, 并显示在显示屏上。这可以让您放心地查看图像。如果不想保存冻结的图像, 可以按下按键 17, 重新进入测量模式。如需将图像保存在摄像头的内部存储器中, 请按下保存键 11。

调取保存的图像

如需调取保存的热成像, 请按如下方式操作:

- 按下左侧功能键 13。现在, 显示屏中显示最后保存的图片。
- 按压向右箭头键 8 或向左箭头键 12, 在保存的热成像之间切换。

删除保存的图像

如需删除特定的热成像, 请进入图库视图:

- 按下回收站图标下的右侧功能键 7。
- 按压左侧功能键 13 确认该操作, 或者按压取消图标下方的右侧功能键 7 中止删除过程。

删除所有图像

在菜单 "删除所有图像" 中可一次性删除内部存储器中的所有文件。

按压按键 "Func" 6, 调出测量功能。现在按压右侧功能键 7, 然后选择 "设备" > "删除所有图像"。按压向右箭头键 8, 进入该子菜单。然后或者按压打勾图标下的左侧功能键 13, 以删除所有文件, 或者按压打叉图标下的右侧功能键 7, 以取消这个过程。

数据传输

通过 USB 接口传输数据

打开 Micro USB 插口的盖子 3。通过配套的 Micro USB 电缆将测量仪的 Micro USB 插口与您的计算机或笔记本电脑连接。

现在通过按键 9 接通热成像摄像头。

打开文件浏览器, 选择驱动器 "BOSCH GTC 400 C"。从测量仪内部存储器可复制已存的 JPG 文件, 将其移动到您的计算机上或删除。

一旦所需的过程结束后, 请按标准流程断开驱动器, 然后通过按键 9 重新关闭热成像摄像头。

在测量运行期间请移除 Micro USB 电缆, 并合上盖板 3。

注意: 请始终先从您的操作系统上移除驱动器 (弹出驱动器), 否则可能会损坏热成像摄像头的内部存储器。

请始终保持 USB 接口盖板关闭, 以免灰尘或溅水进入壳体内。

指示: 测量仪只能与计算机或笔记本电脑连接。如果您将本设备与其它设备相连, 则可能会损坏本设备。

指示: Micro USB 接口仅用于数据传输, 无法为电池和充电电池充电。

热成像的再处理

保存的热成像可以在计算机上 Windows 操作系统下进行再处理。为此, 请在热成像摄像头的产品网页上下载 GTC Transfer 软件, 网址

www.bosch-professional.com/gtc。

24 | 中文

通过 WiFi 传输数据

本测量仪具有一个 WiFi 模块，可以将热成像摄像头保存的图像无线传输到移动终端设备上。

为此，需要将应用程序 (App) "Measuring Master" 作为软件接口。这些应用程序可以根据终端设备在相应的软件商店中下载：



"Measuring Master" 应用除了无线传输图像数据外，还扩张了功能范围，能简化图像的再处理和测量数据的转发（例如通过电子邮件）。如需了解建立 WiFi 连接所需的系统前提条件，请参见博世网站：

"www.bosch-professional.com/gt".

如需激活 / 关闭测量仪上的 WiFi 连接，请调出主菜单，用按键导航，选择 "WiFi"，然后将其激活 / 关闭。在显示屏中出现显示 e。请确保移动终端设备上的 WiFi 接口已激活。

启动博世应用程序后（在 WiFi 模块已激活的情况下），在移动终端设备和测量仪之间建立连接。为此请遵守 "Measuring Master" 应用程序的指导。

故障 – 原因和处理措施

出现故障时，设备会重启，之后可以再次使用。否则，下列一览表可在持续存在故障信息时为您提供帮助。

故障	原因	处理措施
无法开动测量仪器	蓄电池或电池电量已空	给蓄电池充电或更换电池。
	蓄电池过热或过冷	让蓄电池调温或者更换蓄电池。
	测量仪过热或过冷	让测量仪调温。
	图像存储器损坏	通过删除所有图像，格式化内部存储器（参见 "删除所有图像"，第 23 页）。如果问题依然存在，将测量仪发送至经授权的博世售后服务点。
	图像存储器已满	必要时将图像传输到另一个存储介质（例如计算机或笔记本电脑）上。然后删除内部存储器中的图像。
	测量仪损坏	请将探测仪送到经授权的博世售后服务点。
测量仪不能与计算机相连。	计算机未识别到测量仪。	检查您计算机上的驱动程序是否为最新。可能有必要在计算机上安装一个版本更新的操作系统。
	Micro USB 接口或 Micro USB 电缆损坏	检查测量仪能否与其它计算机相连。如果不能，请将测量仪送到经授权的博世售后服务点。

术语解释**红外热辐射**

红外热辐射是每个物体发射出的一种电磁辐射。辐射量取决于物体的温度和辐射率。

辐射率

物体辐射率取决于其表面的材质和结构。它表示物体与理想的热辐射器（黑色物体，辐射率 $\epsilon=1$ ）相比发出多少红外热辐射。

热桥

热桥是指一个无端向外或向内导热并因此显著区别于墙体其余温度或所需温度的物体。

由于热桥上的表面温度低于其余空间中的温度，这个位置上的发霉风险大大提高。

反射温度 / 物体反射性

反射温度是并非由物体自身发出的热辐射。视结构和材料而定，环境辐射在待测物体上反射，从而使原本的温度结果失真。

物体距离

测量物体和测量仪之间的距离影响了每个像素探测的面积大小。物体距离越大，您可以测量的物体就越大。

距离 (米)	红外像素尺寸 (毫米)	红外范围宽度 x 高度 (米)
0.5	3	~0.5 x 0.4
1	6	~1 x 0.75
2	12	2.05 x 1.5
5	30	5.1 x 3.8

TrackMyTools

安装的 **蓝牙® Low Energy** 模块可以个性化设置测量仪并检查其状态，以及在 **蓝牙®** 无线技术的基础上传输设置和数据。

能源供应 TrackMyTools 蓝牙® 模块

测量仪装备了一个纽扣电池，从而在未安装充电电池 23 或电池的情况下，也能由一个移动终端设备通过 TrackMyTools 探测。

更多信息请参阅博世应用程序。

数据传输

TrackMyTools 蓝牙® 模块可以在设备设置中打开或关闭。然后它就会发送一个持续信号。

信号发送周期为 8 秒。根据环境，识别测量仪前可能需要经过 3 个发送周期。

指示： 当您处于禁止发送无线电波的某个地方时（例如在飞机内），请关闭 TrackMyTools。

应用程序 / 网络应用程序的注册和设置

为了使用 TrackMyTools，必须首先进行在线注册。为此打开网页 www.bosch-trackmytools.com 并注册。注册后您会收到访问数据。

请通过相关的应用商店（Apple App Store、Google Play Store）下载应用程序 **TrackMyTools**，或者通过 <https://web.bosch-trackmytools.com> 调取网页应用。在此可以输入访问数据进行注册。

现在您可以借助应用程序 / 网络应用程序创建和管理您的库存。

指示： 首先请通读应用程序 / 网络应用程序的指南。这样对创建库存时的操作步骤和对软件的操作就会有一个更好的全面了解。

维修和服务

维修和清洁

只可在合适的容器中存放和运输测量仪，例如原包装或保护袋（附件）。在测量仪上的红外传感器周围不可粘贴任何标签。

测量仪器必须随时保持清洁。

清洁时不允许有液体渗入测量仪中。

请勿尝试用尖锐物体去除传感器、摄像头或接收镜头上的污物，并且不得从摄像头和接收镜头上面擦拭（划伤危险）。

如需重新校准测量仪，请联系博世售后服务中心（地址见章节“顾客服务处和顾客咨询中心”）。

如要进行修理，请将测量仪放在原包装或保护袋（附件）中发送。

要进行废弃处理，只能由专业人员取下内置纽扣电池。打开壳体可能损坏测量仪。旋出外壳上的螺栓并取下壳体，以便取出纽扣电池。

顾客服务处和顾客咨询中心

本公司顾客服务处负责回答有关本公司产品的修理、维护和备件的问题。以下的网页中有爆炸图和备件的资料：

www.bosch-pt.com

博世顾客咨询团队非常乐意为您解答有关本公司产品及附件的问题。

如需查询和订购备件，请务必提供产品型号铭牌上的 10 位数字号。

有关保证、维修或更换零件事宜，请向合格的经销商查询。

中国大陆

博世电动工具（中国）有限公司

中国 浙江省 杭州市

滨江区滨康路 567 号

邮政编码：310052

免费服务热线：4008268484

传真：(0571) 87774502

电邮：contact.ptcn@cn.bosch.com

www.bosch-pt.com.cn

羅伯特·博世有限公司

香港北角英皇道 625 號 21 樓

客戶服務熱線：+852 2101 0235

傳真：+852 2590 9762

電郵：info@hk.bosch.com

網站：www.bosch-pt.com.hk

制造商地址：

Robert Bosch Power Tools GmbH

羅伯特·博世电动工具有限公司

70538 Stuttgart / GERMANY

70538 斯图加特 / 德国

搬运

根据危险物品法规，您使用的锂离子蓄电池属于危险物品。您可以在马路上搬运蓄电池，不必覆盖住蓄电池。

如果交给第三者运送（例如透过空运或海运），要注意有关包装和标示的特殊要求。在包装处理寄送物时必须要有危险物品的专家在场。

26 | 中文

必須確定蓄電池壳完損時，才可以寄送蓄電池。粘住曝露在外的觸點，並包裝好蓄電池不可以讓它在包裝盒中晃動。
也要注意貴國的相关延伸法規。

處理廢棄物



應對測量儀、蓄電池 / 電池、附件和包裝進行環保的回收利用。



不可以把損壞的探測儀和蓄電池 / 電池丟棄在一般的家庭垃圾中！

充電電池 / 電池：

鋰離子：

請注意“搬運”段落中的指示，頁 25。

保留修改權

中文

安全規章



您必須完整詳讀本安全規章並確實遵照其內容。若未依照現有之說明內容使用測量工具，測量工具內部所設置的防護措施可能無法發揮應有功效。請妥善保存本安全規章。

- ▶ 本測量儀只能交給合格的專業人員修理，而且只能使用原廠的備件。如此才能夠確保儀器的安全性能。
- ▶ 不要在易爆環境，如有易燃液體，氣體或粉塵的環境下操作測量儀器。測量儀器內可能產生火花並點燃粉塵和氣體。
- ▶ 在測量工具上進行任何作業（例如安裝、保養等等）以及搬運、收納測量工具之前，必須先將充電電池或一般電池從測量工具中取出。
- ▶ 不可以打開蓄電池。有短路的危險。



蓄電池必須遠離高溫，蓄電池也要避開持續的日照、火焰、水和濕氣。有爆炸的危險。



- ▶ 不使用的蓄電池要遠離回紋針、硬幣、鑰匙、釘子、螺絲或其他可能橋接觸點的小金屬物體。蓄電池的觸點如果產生短路，可能著火或造成火災。
- ▶ 如果濫用蓄電池，可能從蓄電池中滲出液體。避免接觸此液體。如果不小心中觸到了要用水沖刷。萬一該液體進入眼中必須盡快就醫。從蓄電池滲出的液體可能刺激皮膚或灼傷皮膚。

▶ 損壞的和被濫用的蓄電池會冒出蒸氣，因此要確保工作場所空氣流通。身體如果出現任何不適得盡快就醫。此蒸氣可能刺激呼吸道。

- ▶ 只能使用製造廠商推薦的充電器為蓄電池充電。使用針對特定蓄電池的充電器替其他的蓄電池充電，可能會釀成火災。
- ▶ 本蓄電池只能安裝在博世的測量儀器上使用。只有這樣才能夠保護蓄電池，避免發生危險的過載情形。
- ▶ 尖銳物品（例如釘子或螺絲起子）或是外力皆有可能造成充電電池損壞，進而導致內部短路而發生電池起火、冒煙、爆炸或過熱等事故。
- ▶ 電池轉接器僅能在規定的博世測量工具上使用，不得搭配電動工具一起使用。
- ▶ 如果長期不使用測量儀，必須從測量儀器中取出電池。經過長期擱置，電池會腐蝕或自行放電。
- ▶ 妥善保護測量工具，尤其是攝影鏡頭與紅外線透鏡這兩個地方，應避免水氣滲入或沾上落雪。接收點的透鏡可能起霧而造成測量結果產生誤差。裝置若設定錯誤，或是受到其他天候因素的影響，皆可能導致測量發生錯誤。物體實際溫度可能比顯示值更高或更低，因此碰觸時可能發生危險。
- ▶ 溫度落差若太大，可能造成熱影像中以代表低溫的顏色顯示高溫。若直接碰觸，人員可能灼傷！
- ▶ 唯有當您所設定的發射率與物體發射率一致時，所測量出來的溫度才會正確。物體實際溫度可能比顯示出來的溫度值和 / 或色溫更高或更低，因此碰觸時可能發生危險。
- ▶ 小心！使用測量工具時若開啟塵芽® 功能，將可能對其他裝置或設備，飛機以及醫療器材（例如心律調節器，助聽器等）產生干擾。同樣亦無法完全排除對鄰近之人員或動物造成身體危害的可能性。請勿在醫療器材，加油站，化學設備，爆炸危險場所以及易爆環境等處附近，使用測量工具的塵芽® 功能。請勿在飛機上使用測量工具的塵芽® 功能。應避免直接貼靠在身體部位旁的長時間持續操作。
- ▶ 本測量工具配備無線介面。請您務必遵守不同場所的使用限制條件，例如在飛機或醫院內。

產品和功率描述

塵芽® 一詞及其標誌（商標）為 Bluetooth SIG, Inc. 所擁有之註冊商標。Robert Bosch Power Tools GmbH 對於此詞彙 / 標誌之任何使用均已取得授權。

按照規定使用機器

此熱影像鏡頭適合用於非接觸性的表面溫度測量作業。

顯示出來的熱影像即為紅外線透鏡偵測區域內的溫度分佈圖，它利用顏色來呈現細微的溫度變化。

應用於專業領域時，不必有任何接觸即可查明表面及物體的溫度落差以及溫度異常，讓您一眼就能看清部件位置以及／或可能存在的破綻，其中包含：

- 隔熱措施與絕緣層（例如發現熱橋現象）
- 地板與牆面內有水正在流動的熱水管（例如地暖設備）
- 過熱的電子組件，例如保險絲或端子
- 機器構件（例如因滾珠軸承故障而過熱）

本測量工具不得用於測量人體或動物的體溫，亦不可做為其他醫療用途。

本測量工具不適合用於測量氣體或液體的表面溫度。

插圖上的機件

機件的編號和儀器詳解圖上的編號一致。

- 1 攝影鏡頭與紅外線感應器的護蓋
- 2 序列號碼
- 3 Micro USB 插孔蓋
- 4 Micro USB 插孔
- 5 上箭頭按鈕
- 6 "Func" 測量功能按鈕
- 7 溫度刻度自動與固定模式切換／右側功能按鈕
- 8 右箭頭按鈕
- 9 起停開關
- 10 下箭頭按鈕
- 11 儲存按鈕
- 12 左箭頭按鈕
- 13 圖庫按鈕／左側功能按鈕
- 14 螢幕

技術性數據

熱影像鏡頭	GTC 400 C
物品代碼	3 601 K83 1..
紅外線感應器解析度	160 x 120
熱靈敏度	< 50 mK
頻譜範圍	8 - 14 μm
可視角 (FOV)	53 x 43°
焦距	≥ 0.3 米
聚焦	固定式
表面溫度測量範圍	-10...+400 °C

儀器銘牌上的序列號碼（儀器詳解圖上標示 2 的位置）便是儀器的識別碼。

- 1) 環境溫度為 20 - 23 °C、發射率 > 0.999、測量距離：0.3 m、操作時間：> 5 min
 - 2) 溫度 < 0 °C 時，性能受限
- 使用附帶的蓄電池所測得的技術數據。

- 15 攝影鏡頭
- 16 紅外線感應區
- 17 凍結測量／接續測量按鈕
- 18 蓄電池室
- 19 充電電池／電池轉接器的解鎖按鈕
- 20 電池轉接器的密封端蓋*
- 21 電池盒*
- 22 匣套凹槽
- 23 蓄電池*
- 24 Micro USB 傳輸線
- 25 保護套*

*插圖中或說明書中提到的附件，并不包含在正常的供貨範圍中。

顯示圖

- a 日期／時間
- b 測量功能
- c 發射率指示器
- d 藍牙® 連線指示器
- e WiFi 啟動／關閉指示器
- f 電容量的顯示燈號
- g 測量範圍最高表面溫度指示器
- h 刻度
- i 測量範圍最低表面溫度指示器
- j 刻度鎖定符號
- k 最高溫點指示器（僅為範例圖示）
- l 附帶溫度指示器的十字交叉線
- m 最低溫點指示器（僅為範例圖示）
- n 圖庫符號

28 | 中文

熱影像鏡頭		GTC 400 C
測量精度 (一般)		
表面溫度¹⁾		
-10...+10 °C		±3 °C
10...100 °C		±3 °C
>+100 °C		±3 %
螢幕類型		TFT
螢幕尺寸		3.5"
顯示屏解析度		320 x 240
圖檔格式		.jpg
每次執行儲存時實際儲存的圖片		1 張熱影像 (擷圖) 1 張實景照片, 內含溫度值 (中繼資料)
內部記憶體可容納的圖片張數 (標準)		500
內建攝影鏡頭		●
電池 (鹼 - 錳)	4 x 1.5 伏特 LR6 (AA) (含電池轉接器)	
蓄電池 (鋰離子)	10.8 伏特 / 12 伏特	
USB 連接埠		1.1
TrackMyTools 藍牙® 模組的電源		
- 鈕扣電池	CR2450 (3V 鋰電池)	
- 電池使用壽命大約	60 個月	
藍牙®	藍牙® 4.2 (低功耗)	
藍牙® 最大發射功率		3.2 毫瓦
波段 藍牙®		2.402 - 2.480 GHz
無線連接方式		WiFi
WiFi 最大發射功率		30 毫瓦
WiFi 工作頻率範圍		2.400 - 2.483 GHz
重量符合 EPTA-Procedure 01:2014		0.54 公斤
尺寸 (長 x 寬 x 高)		233 x 95 x 63 毫米
保護等級 (不包含電池盒)		IP 53
容許的環境條件		
- 充電溫度		0...+45 °C
- 操作溫度 ²⁾		-10...+45 °C
- 儲藏溫度範圍		-20...+70 °C
- 空氣相對濕度 (未凝結)		20...80 %
建議使用之充電電池		GBA 10,8 V GBA 12 V
建議使用的充電器		AL 11.. CV GAL 12.. CV

儀器銘牌上的序列號碼 (儀器詳解圖上標示 2 的位置) 便是儀器的識別碼。

1) 環境溫度為 20 - 23 °C、發射率 > 0.999、測量距離: 0.3 m、操作時間: > 5 min

2) 溫度 < 0 °C 時, 性能受限

使用附帶的蓄電池所測得的技術數據。

安裝

電源供應

此測量工具可使用市售的一般電池 (LR6 型 AA 電池或其他可替代的電池) 或博世鋰離子充電電池來進行驅動。

透過電池轉接器供電 (可取出) (參考插圖 A)

電池先放入電池轉接器內。

- ▶ **電池轉接器僅能在規定的博世測量工具上使用，不得搭配電動工具一起使用。**

將電池轉接匣 21 推入電池盒 18 中，以便裝入電池。請按照插圖所示，將電池先嵌在密封端蓋 20 上後，再放入匣套裡。請推移密封端蓋，讓它覆蓋在匣套上，直到可感覺到已卡上並且與測量工具的把手貼齊。



若要取出電池，請按壓密封端蓋 20 的解鎖按鈕 19，並將密封端蓋拔下。此時請注意：不可讓電池掉出來。此外，該測量工具的電池盒 18 應保持朝上。取出電池。若欲將已放入的轉接匣 21 從電池盒 18 中拿出來，請將手伸到匣套凹槽 22 內，然後輕輕按壓側壁並同時將它從測量工具中拔出 (參考插圖 B)。

指示： 取出充電電池時，請勿使用任何工具 (例如螺絲起子)，否則可能造成匣套斷裂。

務必同時更換所有的電池。請使用同一製造廠商，容量相同的電池。

- ▶ **如果長期不使用測量儀，必須從測量儀器中取出電池。** 經過長期擱置，電池會腐蝕或自行放電。

以蓄電池驅動 (參考插圖 C)

指示： 使用了不適合測量儀器的蓄電池可能造成測量儀器故障或損壞測量儀器。

指示： 蓄電池在供貨時只完成了部分充電。為了確保它能夠發揮最大的功效，首度使用前得先以充電器替蓄電池充足電。

- ▶ **只能選用技術性數據裡所列出的充電器。** 僅有這些充電器適用於測量工具所使用的鋰離子充電電池。

您可以隨時替鋰離子蓄電池充電，不必擔心會縮短它的使用壽命。中斷充電過程也不會損壞蓄電池。

- ▶ **測量工具自動關機後，請勿再按壓開關按鈕。** 否則充電電池可能會損壞。

若要裝入已充好電的充電電池 23，請將它推入電池盒 18，直到可感覺到已卡上並且與測量工具的把手貼齊。

若要取出充電電池 23，請按壓解鎖按鈕 19 並同時將充電電池拔出電池盒 18。**不可以強行拉出充電電池。**

蓄電池充電電量指示燈

顯示器中的充電電量指示器 f 可告知一般電池或充電電池 23 的目前電量。

顯示圖	容量
	> 2/3
	≤ 2/3
	≤ 1/3
	≤ 10%
	更換一般電池或充電電池

正式操作

- ▶ **不可以讓濕氣滲入儀器中，也不可以讓陽光直接照射在儀器上。**

- ▶ **儀器不可以曝露在極端的氣候下，也不可以把儀器放在溫差相當大的環境中。** 例如儀器不可以長期放置在汽車中。如果儀器先后曝露在溫差相當大的環境中，必須先等待儀器的溫度恢復正常後再使用儀器。如果儀器曝露在極端的氣候下或溫差相當大的環境中，會影響儀器的測量準確度。

- ▶ **請注意：須讓測量工具完全適應氣候。** 溫度波動劇烈或環境條件大幅變動時，在測量裝置完全適應氣候之前，其測量準確度可能會受到影響。

- ▶ **測量工具須避免猛力碰撞或翻倒。** 測量工具遭受外力衝擊後，功能上若有任何異常，則應將它送交本公司授權的博世客戶服務中心進一步檢修。

操作

開動 / 關閉

掀開護蓋 1 以便進行測量。**執行此項動作時，請注意：不可堵住或遮蓋到紅外線測量範圍。**

若要啟動測量工具，請按一下電源按鈕 9。顯示器 14 中顯示正在啟動。測量工具完成啟動程序後便立即開始進行測量，並將一直持續到關閉電源為止。

指示： 一開始的數分鐘，測量工具可能會不斷地自我校正，這是因為感應器還沒適應環境溫度。重新校準可讓您取得精準的測量結果。校準期間熱影像會短暫凍結。

若要關閉測量工具，請再按一次電源按鈕。本測量工具會先將所有設定儲存起來後才關機。闔上護蓋 1 以確保測量工具可安全地進行搬運。

您可到設定功能表中選擇，要在沒有按下任何按鈕的時間持續多久以後讓測量工具自動關機或要停用此項功能 (請參閱第 32 頁的 "關機時間")。

充電電池或測量工具的操作溫度只要一超出技術性數據中的規定值，本測量工具將在簡要示警之後隨即自動關閉 (請參閱第 33 頁的 "故障 - 原因和處理措施")。請讓測量工具回溫後再重新開機。

30 | 中文

測量事前準備**設定表面溫度測量的發射率**

測量標的物的發射率根據其材質及表面結構而有所不同。從此一數值您可以知道，該物體（與其他具有相同溫度的物體相比之下）發散出的紅外線熱輻射是多還是少。

表面溫度的判定並不需要接觸測量標的物，而是直接估量該物自然發散的紅外線熱輻射。為確保正確進行測量，**每次測量前**都必須檢查測量工具上所設定的發射率，必要時請配合測量標的物進行調整。

您可以從發射率預設值中挑選，或者直接輸入一個準確的數值。請透過 "測量" 功能表 > "發射率"，設定您想要使用的發射率（請參閱第 31 頁）。

▶ **唯有當您所設定的發射率與物體發射率一致時，所測量出來的溫度才會正確。**

顏色之所以會有差異，可能是源自於溫度及 / 或發射率不同。因此，如果發射率相差極大，那麼所呈現出來的溫差可能明顯偏離實際情況。

如果測量範圍內同時存在多種不同材質或不同結構的測量標的物，那麼所顯示的溫度值僅對適用目前發射率的物體具有參考價值。對於（擁有不同發射率的）其他所有物體而言，所顯示的溫差僅可用來參考溫度相對高低。

物料	發射率 (基準值 0 °C 至 100 °C)
混凝土	0.93
石膏 / 水泥坭料	0.93
磚塊	0.93
屋頂油氈	0.93
散熱漆	0.93
木材	0.91
亞麻地板	0.88
紙類	0.89

測量條件的相關注意事項

反射率高的表面或平滑發光的表面（例如反光瓷磚或裸金屬）可能會干擾測量或造成測量結果會有誤差。您可視需要用導熱佳的深色非亮面膠帶貼住測量面。然後讓膠帶先閒置一段時間，使它與底下的表面達到均溫。

請注意：如果是會反射的表面，則必須調整至最佳測量角度，不要因為從其他測量標的物反射過來的熱輻射造成測量結果產生誤差。舉例來說，您自身的體溫反射可能會干擾到前方的垂直測量。測量平坦表面時，儀器上所顯示的可能是您身體的輪廓及體溫（反射值），而不是接受測量之表面的真正溫度（表面的發射值或實際值）。

原則上，無法穿透過透明材質（例如玻璃或透明塑膠）後，測量位於其後方的表面。

測量條件愈佳、愈穩定，其測量結果也就更準確、可信度更高。

煙霧、蒸汽、混濁的空氣或空氣濕度極高時，皆會干擾紅外線溫度測量。

提升測量精準度的技巧：

- 儘可能接近測量標的物，讓您與測量表面之間的干擾因素降至最低。
- 在室內進行測量之前，請先通風，尤其是在空氣髒污或充滿蒸汽的情況下。
通風後，請稍待片刻讓室內回溫至正常溫度。

依據刻度尺配置溫度顏色

顯示器的右邊有一個刻度尺。上下兩端的數值即是熱影像中所偵測到的最高溫及最低溫。圖中將依照線性均勻分配代表溫度值的顏色。

透過不同的色調來表達兩個臨界值之間的溫度。因此只要是正好位於最大值與最小值之間的溫度，便可在刻度尺的中間色域中找到它的顏色。

若要測量某一具體地點的溫度，請移動測量裝置，讓附帶溫度指示器的十字交叉線 I 對準您想要測量的位置或區域。

選擇自動設定時，刻度尺的色譜一律依照整個測量範圍的最高溫和最低溫採線性分配（即均勻分配）。

從熱影像鏡頭就可以知道測量範圍內所有溫度測量值彼此間的相對關係。舉例來說，如果某一區塊以偏藍色調顯示其熱度，這表示在整個實際測量範圍內它偏屬較低溫。但此一區塊的溫度實際上可能已經是會導致人員受傷的高溫。因此，請您隨時留意刻度尺上或是十字交叉線旁所顯示的溫度值。

**功能****調整色彩顯示**

根據實際測量狀況以不同色域顯示溫度，可讓您可容易分析熱影像，並使顯示器中的物體或真實情況呈現得更加清楚。這樣做並不影響您所測得的溫度值。僅僅是改變了溫度值的顯示方式而已。

若要切換溫度顯示的色域，請您留在測量模式中，然後按一下右箭頭按鈕 8 或左箭頭按鈕 12。

套疊熱影像和實景

在環境已達均溫的情況下，為了方便您定位（即：將顯示的熱影像對照現場位置），可開啟實景影像。

指示：相隔 0.55 m 的距離時，實景和熱影像可精準套疊。與測量標的物相隔的距離若不是此值，實景與熱影像可能會有錯位現象。

熱影像鏡頭為您提供以下功能選項：

- **100 % 紅外線影像**
僅顯示熱影像。
 - **實景模式**
熱影像經裁切後，嵌入在實景中。此一設定選項可讓您更容易判別測量區的方向。
 - **透明化**
熱影像以稍微穿透的方式顯示，其底下是實景影像。此一功能可方便您辨別物體。
- 按一下向上箭頭按鈕 5 或向下箭頭按鈕 10，即可調整此一設定。

固定刻度尺

熱影像將自動調整配色，而且只要按一下右側功能按鈕 7 即可凍結設定。這項功能是為了方便您比對在不同溫度條件下拍攝的熱影像（例如檢測不同空間的熱橋現象時）。

若要将刻度尺切換為自動，請再按一次右側功能按鈕 7。於是裝置重新改回至動態模式，將配合所測得的最大值及最小值調整溫度顯示方式。

測量功能

如果想要執行其他的顯示輔助功能，請按一下 "Func" 按鈕 6。利用向右 / 向左瀏覽畫面上的選項，以便選擇功能。選取功能後，請再按一次 "Func" 按鈕 6。

以下是供您選用的測量功能：

- **"自動"**
熱影像將自動調整配色。
- **"熱點追蹤"**
此一測量功能將使熱影像僅顯示測量範圍中屬於高溫的部份。高溫部份以外的範圍將以灰階實景顯示，於是從顏色便可正確判斷物體的溫度（例如：追查過熱組件時配電箱中以紅色顯示的電纜）。請利用向上按鈕 5 及向下按鈕 10 配合調整刻度尺。您可藉此拉大或縮小所顯示的溫度範圍。裝置仍將同時測量最高溫及最低溫，並將它們顯示於刻度尺的兩端。但您可以操控哪個範圍的溫度要在熱影像中以彩色顯現。
- **"冷點追蹤"**
此一測量功能將使熱影像僅顯示測量範圍中屬於低溫的部份。低溫部份以外的範圍將以灰階實景顯示，於是從顏色便可正確判斷物體的溫度（例如：追查絕緣不良處時以藍色顯示的窗框）。請利用向上按鈕 5 及向下按鈕 10 配合調整刻度尺。您可藉此拉大或縮小所顯示的溫度範圍。裝置仍將同時測量最高溫及最低溫，並將它們顯示於刻度尺的兩端。但您可以操控哪個範圍的溫度要在熱影像中以彩色顯現。
- **"手動"**
如果熱影像中所測得的溫度落差極大（例如：探查熱橋現象時，高溫物體即為加熱裝置），最大值與最小值之間有大量的溫度數值要來一起分配顯現的顏色。於是畫面上很可能就無法區別出細微的溫差。如果想要畫面聚焦在細部溫度，請按以下方式

操作：先切換至 "手動" 模式，接著您便可設定最高溫及最低溫。此一方法可讓您將溫度範圍指定在想要追看細微溫差的相關範圍。利用 **重置** 設定，即可讓刻度尺重新設回：自動配合紅外線感應器偵測範圍內所測得的數值進行調整。

主功能表

若要進入主功能表，請按一下 "Func" 按鈕 6，以執行測量功能。現在，請您按一下右側功能按鈕 7。

- **"測量"**
 - **"發射率" c:**
本產品中已預先儲存了一些最常見材質的發射率，供您選擇。請到 "材質" 功能表選項中選擇符合的材質。其下便是該材質的發射率。
如果您已知道測量標的物的正確發射率，則可直接到 "發射率" 功能表選項中輸入該值。
 - **"反射溫度" d:**
設定此參數可改善測量品質，尤其是低發射率的材質 (= 高反射率)。大部份情況下，反射溫度與環境溫度相等。
當您測量溫度落差大的物體時，附近若有反射性強的材料就很容易影響測量結果，此時應調整此值的設定。
- **"顯示器"**
 - **"最高溫點" k: "開 / 關"**
使用此項功能時，熱影像中將出現一個紅色十字交叉線，自動標示出測量範圍內的最高溫位置 (= 測量像素)。讓您能夠輕鬆找出關鍵位置，例如配電箱內鬆脫的端子。
 - **"最低溫點" m: "開 / 關"**
熱影像中將出現一個藍色十字交叉線，自動為您標示出測量範圍內的最低溫位置 (= 測量像素)。讓您能夠輕鬆找出關鍵位置，例如隔離部件上的洩漏處。
 - **"十字交叉線" l: "開 / 關"**
十字交叉線將出現熱影像的正中，並且告知該處所測得的溫度值。
 - **"刻度尺" h: "開 / 關"**
- **"WiFi": "開 / 關"**
(請參閱第 32 頁的 "資料傳輸")
- **"Track My Tools": "開 / 關"**
(請參閱第 34 頁的 "TrackMyTools")
- **"裝置"**
 - **"語言"**
您可到此功能表項目下設定所有顯示畫面要使用的語言。
 - **"時間與日期" a**
如欲變更畫面上的日期與時間，請開啟 "時間與日期" 子功能表。此外，您亦可在此子功能表中變更日期與時間的格式。
離開 "時間與日期" 子功能表時，若是按一下位於打勾符號底下的左側功能按鈕 13 則將儲存您的設定；若是按一下位於打叉符號底下的右側功能按鈕 7，代表您要捨棄變更。

32 | 中文

- "聲音訊號": "開/關"

您可在此功能表項目底下開啟/關閉聲音訊號。

- "關機時間"

您可在此功能表項目底下選擇，要在沒有按下任何按鈕的時間持續多久以後讓測量工具自動關機。您也可藉由選擇 "永不" 此一設定來停用自動關機功能。

- "刪除所有圖片"

您可在此功能表項目底下，一次將內部記憶體裡的所有檔案全部刪除。在出現 "其他 ..." 時按一下右箭頭按鈕 8 即可進入子功能表。若是按一下位於打勾符號底下的左側功能按鈕 13 即可刪除所有檔案，或者亦可按一下打叉符號底下的右側功能按鈕 7 以便取消此項作業。

- "裝置資訊"

您可在此功能表項目底下，開啟本測量工具的相關資訊。您可在此處找到測量工具的序號及其安裝的軟體版本。

您亦可按一下 17 按鈕，如此即可離開任一功能表並返回標準顯示畫面。

測量結果文檔

儲存測量結果

測量工具啟動後便會直接開始進行測量，並將一直持續到關閉電源為止。

若要儲存圖片，請將攝影鏡頭對準測量標的物，然後按一下儲存按鈕 11。圖片將存放在攝影鏡頭的內部記憶體中。或者，按一下凍結測量按鈕 17。系統隨即凍結測量程序，並在顯示器上為您顯示相關內容。此項功能可讓您從容檢視圖片。如果您不想儲存這張凍結的圖片，請利用按鈕 17 重新回到測量模式。如果想將這張圖片儲存至攝影鏡頭的內部記憶體，請按一下儲存按鈕 11。

開啟已儲存的圖片

若要開啟已儲存的熱影像，請按以下方式操作：

- 按一下左側功能按鈕 13。顯示器中隨即顯示最後儲存的擷圖。
- 按一下右箭頭按鈕 8 或左箭頭按鈕 12，即可在已儲存的熱影像之間進行切換。

刪除已儲存的圖片

若要刪除單張熱影像，請到圖庫檢視底下：

- 按一下垃圾桶圖示底下的右側功能按鈕 7。
- 請按一下左側功能按鈕 13 確認此項作業，或者亦可按一下取消圖示底下的右側功能按鈕 7 以便取消此一刪除作業。

刪除所有圖片

您可在 "刪除所有圖片" 功能表中，一次將內部記憶體裡的所有檔案全部刪除。

按一下 "Func" 按鈕 6 即可開啟測量功能。現在請您按一下右側功能按鈕 7，然後選擇 "裝置" > "刪除

所有圖片"。按一下右箭頭按鈕 8，以便進入該子功能表。若是按一下位於打勾符號底下的左側功能按鈕 13 即可刪除所有檔案，或者亦可按一下打叉符號底下的右側功能按鈕 7 以便取消此項作業。

資料傳輸

透過 USB 介面進行資料傳輸

打開 Micro USB 插孔蓋 3。將測量工具的 Micro USB 插孔透過隨附的 Micro USB 傳輸線連接至您的桌上型電腦或行動電腦裝置上。

現在，請利用 9 按鈕啟動熱影像鏡頭。

打開檔案總管，並選擇 "BOSCH GTC 400 C" 磁碟。接著您就可以複製、刪除已儲存在測量工具內部記憶體中的 JPG 檔，或將它移動至您的電腦上。

完成您想執行的動作後，請立即按標準程序與磁碟斷開連線，然後利用按鈕 9 將熱影像鏡頭重新關閉。在測量模式下，拔掉 Micro USB 傳輸線，闔上保護蓋板 3。

注意：務必先將磁碟從您的作業系統上卸除（退出磁碟），否則熱影像鏡頭的內部記憶體可能會受損。

USB 介面的保護蓋板請隨時保持關閉，這樣才不會有灰塵或噴濺的液體跑進機殼內。

指示：測量工具僅可連接至桌上型電腦或筆記型電腦。若是與其他裝置連接，可能會造成本產品損壞。

指示：Micro USB 介面僅可用於資料傳輸 - 一般電池或充電電池不可使用此孔進行充電。

熱影像進行後製加工

已儲存的熱影像可在電腦的 Windows 作業系統底下進行後製加工。若要這麼做，請到熱影像鏡頭的產品網站上下載 GTC Transfer 軟體，網址：

www.bosch-professional.com/gtc。

透過 WiFi 傳輸資料

本測量工具配有一個 WiFi 模組，可讓您將已儲存的圖片以無線方式從熱影像鏡頭傳輸至終端行動裝置上。

此時您將需要使用 "Measuring Master" 應用程式

(App) 做為軟體介面。您可到相關商店按照所使用的終端裝置下載該程式：



除了無線傳輸您的圖片資料外，"Measuring Master" 這個應用程式還可為您提供擴充功能、簡化測量資料的後製加工流程，並轉傳測量資料（例如透過電子郵件

件)。如需 WiFi 連線的最低系統需求相關資訊，請至博世網站：["www.bosch-professional.com/gtc"](http://www.bosch-professional.com/gtc)。

若要啟用 / 停用測量工具上的 WiFi 連線，請開啟主功能表，利用按鈕進入 "WiFi" 選項，然後在此啟用 / 停用此項功能。顯示器中將隨即出現指示器 **e**。請確認：終端行動裝置上的 WiFi 介面已啟用。

博世應用程式啟動之後，（在 WiFi 模組已啟用的狀態下）可讓終端行動裝置與測量工具之間自動建立連線。請您遵照 "Measuring Master" 應用程式上的指示即可。

故障 – 原因和處理措施

若發生故障，本裝置將重新啟動，然後便可重新連線。萬一持續出現故障訊息時，以下列出的一覽表將可為您提供協助。

故障	原因	處理措施
無法開動測量儀器	充電電池或一般電池已無電力	請為充電電池進行充電或更換一般電池。
	充電電池溫度過高或過低	請讓充電電池回溫或直接進行更換。
	測量工具溫度過高或過低	讓測量工具回溫。
	圖片儲存記憶體故障	請藉由刪除所有圖片（詳細第 32 頁的 "刪除所有圖片"）將內部記憶體重新格式化。如果之後仍然持續發生問題，請將測量工具送交本公司授權的博世客戶服務中心進一步檢修。
	圖片儲存記憶體已滿	請依需要將圖片轉移至其他儲存設備（例如桌上型電腦或筆記型電腦）。然後刪除內部記憶體中的圖片。
	測量工具故障	請將測量工具送交本公司授權的博世客戶服務中心進一步檢修。
測量工具無法與桌上型電腦連線。	桌上型電腦無法識別本測量工具。	請檢查電腦上是否為最新的驅動程式。必要時，桌上型電腦必須使用更新的作業系統版本。
	Micro USB 連接埠或 Micro USB 傳輸線故障	請測試本測量工具是否能夠與另一台桌上型電腦連線。如果不能，請將測量工具送交本公司授權的博世客戶服務中心進一步檢修。

名詞解釋

紅外線熱輻射

紅外線熱輻射是一種由任何物體發散的電磁輻射。其輻射量取決於物體的溫度及發射率。

發射率

測量標的物的發射率根據其材質及表面結構而有所不同。此值代表，相較於理想的熱輻射物體（即黑體，其發射率 $\epsilon=1$ ），測量標的物所釋放的紅外線熱輻射量。

熱橋現象

一個物體如果具有將熱能往外部或往內部排擠的不良現象，繼而與牆面的其他正常溫度 / 所需溫度之間形成相當大的落差，而這就叫做熱橋現象。

熱橋部位上的表面溫度較其他地方低，因此該處的發霉疑慮大增。

反射溫度 / 物體的反射特性

所謂反射溫度係指非物體自身發散的熱輻射。環境輻射會受到物體結構及材質的影響，反射到欲進行測量的物體上，所以當您對物體進行溫度測量時，得出的數值會失真。

物體距離

測量標的物與測量裝置相隔的距離將影響每一像素所偵測的面積大小。與物體之間的距離愈長，您可偵測的物體就愈大。

距離 (米)	紅外線像素尺寸 (毫米)	紅外線範圍 (寬 x 高) (米)
0.5	3	~0.5 x 0.4
1	6	~1 x 0.75
2	12	2.05 x 1.5
5	30	5.1 x 3.8

34 | 中文

TrackMyTools

內建的**藍牙®** Low Energy Module 可讓您命名識別測量工具並對其進行狀態檢測，運用**藍牙®** 無線技術還可傳輸設定和資料。

TrackMyTools 藍牙® 模組的電源

測量工具裝上一顆鈕扣電池後，亦可在不使用充電電池 23 或一般電池的狀態下，讓終端行動裝置透過 TrackMyTools 偵測到它的存在。

如需其他詳細資訊，請直接參考**博世 App**。

資料傳輸

您可在裝置設定中開啟或關閉 TrackMyTools **藍牙®** 模組。接下來它會持續發送訊號。

該模組的發送間隔時間為八秒。視環境條件而定，可能需要發送三回，才能偵測到測量工具。

指示： 當您身處禁止發送無線電波的區域內時（例如車上），請將 TrackMyTools 關閉。

註冊與設置 App / 網路應用程式

您必須先至線上註冊，才能開始使用 TrackMyTools。

請開啟網站 www.bosch-trackmytools.com 並進行註冊。完成註冊後，即可取得您的登入資料。

請至對應的 App 商店 (Apple App Store, Google Play Store 商店) 下載 **TrackMyTools** App，或者您亦可到 <https://web.bosch-trackmytools.com> 執行此網路應用程式。在此處提供您的登入資料後，即可登入。

於是您現在可以在 App / 網路應用程式的協助之下建立並管理您的工具庫。

指示： 請先完成 App / 網路應用程式的所有教學課程。藉此，您對於建立工具庫和操作軟體的流程會有比較全面性的瞭解。

維修和服務**維修和清潔**

運送或貯存本測量工具時，請務必將它放入適當的容器內，例如原廠包裝盒或保護套袋（配件）。不可在測量工具的紅外線感應器附近黏貼任何帶膠籤條。

測量儀器必須隨時保持清潔。

進行清潔時，切勿讓任何液體滲入測量工具。

請勿試圖用尖銳物品去除感應器、攝影鏡頭或接收點上的髒污，亦不可直接擦拭攝影鏡頭與接收點（可能造成細微刮痕）。

若是想要重新校正您的測量工具，請洽詢**博世客服中心**（聯絡方式請參考“顧客服務處和顧客諮詢中心”小節）。

如需送修，請將測量工具妥善放入原廠包裝盒或保護套袋（配件）內後，再轉交給相關單位。

如果是內建式鈕扣電池，則必須由專業人員拆下後進行回收。任意拆開測量工具外殼，可能導致其毀損。卸下機殼上的螺栓後，拆開外殼，然後就可以將鈕扣電池取出。

顧客服務處和顧客諮詢中心

本公司顧客服務處負責回答有關本公司產品的修理、維護和備件的問題。以下的網頁中有爆炸圖和備件的資料：

www.bosch-pt.com

博世顧客諮詢團隊非常樂意為您解答有關本公司產品及附件的問題。

當您需要諮詢或訂購備用零組件時，請務必提供本產品型號銘牌上的 10 位項目編號。

台灣

台灣羅伯特博世股份有限公司

建國北路一段 90 號 6 樓

台北市 10491

電話：(02) 2515 5388

傳真：(02) 2516 1176

www.bosch-pt.com.tw

制造商地址：

Robert Bosch Power Tools GmbH

羅伯特·博世電動工具有限公司

70538 Stuttgart / GERMANY

70538 斯圖加特 / 德國

搬運

根據危險物品法規，您使用的鋰離子蓄電池屬於危險物品。您可以在馬路上搬運蓄電池，不必覆蓋住蓄電池。

如果交給第三者運送（例如透過空運或海運），要注意有關包裝和標示的特殊要求。在包裝處理寄送物時必須有危險物品的專家在場。

必須確定蓄電池殼無損時，才可以寄送蓄電池。粘住曝露在外的觸點，並包裝好蓄電池不可以讓它在包裝盒中晃動。

也要注意貴國的相關延伸法規。

處理廢棄物

測量工具、充電電池 / 一般電池、配件以及包裝材料須遵照環保相關法規進行資源回收。



不可以把損壞的測距儀和蓄電池 / 電池丟棄在一般的家庭垃圾中！

蓄電池 / 一般電池：**鋰離子：**

請注意“搬運”段落中的指示，頁 34。

保留修改權

NCN 警語

低功率電波輻射性電機管理辦法

第十二條經型式認證合格之低功率射頻電機，非經許可，公司，商號或使用者均不得擅自變更頻率，加大功率或變更原設計之特性及功能。
 第十四條低功率射頻電機之使用不得影響飛航安全及干擾合法通信；經發現有干擾現象時，應立即停用，並改善至無干擾時方得繼續使用。
 前項合法通信，指依電信規定作業之無線電信。
 低功率射頻電機須忍受合法通信或工業，科學及醫療用電波輻射性電機設備之干擾。

한국어

안전 수칙



제시된 모든 지침을 숙지하고 이를 준수해야 합니다. 측정공구를 해당 지침에 따라 사용하지 않으면, 측정공구에 내장되어 있는 안전장치에 안좋은 영향을 미칠 수 있습니다. 본 설명서를 잘 보관하시기 바랍니다.

- ▶ 측정공구의 수리는 해당 자격을 갖춘 전문 인력에게 맡기고, 수리 정비 시 순정 부품만 사용하십시오. 이 경우에만 측정공구의 안전성을 오래 유지할 수 있습니다.
 - ▶ 가연성 유체나 가스 혹은 분진 등 폭발 위험이 있는 곳에서 측정공구를 사용하지 마십시오. 측정공구에 분진이나 증기를 점화하는 스파크가 생길 수 있습니다.
 - ▶ 측정공구에서 각종 작업을 하기 전이나(설치, 유지보수 작업 등), 측정공구를 운반하거나 보관하기 전, 반드시 축전지 또는 배터리를 측정공구로부터 빼십시오.
 - ▶ 충전용 배터리를 분해하지 마십시오. 단락이 발생할 위험이 있습니다.
- 충전용 배터리를 태양 광선 등 고열에 장시간 노출되지 않도록 하고, 물과 불 그리고 수분이 있는 곳에 두지 마십시오. 폭발 위험이 있습니다.
- ▶ 충전용 배터리를 사용하지 않을 때는 각 극 사이에 브리징 상태가 생길 수 있으므로 페이퍼 롤립, 동전, 열쇠, 못, 나사 등 유사한 소형의 금속성 물체에서 멀리하여 보관하십시오. 충전용 배터리 극 사이에 쇼트가 일어나 화상을 입거나 화재가 발생할 수 있습니다.
 - ▶ 충전용 배터리를 잘못 사용하면 누수가 생길 수 있는데 이에 닿지 않도록 하십시오. 피부에 접하게 되었을 경우 즉시 물로 씻어 내십시오. 유체가 눈에 닿았을 경우 바로 의사와 상담하십시오. 충전용 배터리에서 나오는 유체는 피부에 자극을 주거나 화상을 입힐 수 있습니다.

- ▶ 충전용 배터리가 손상되었거나 이를 잘못 사용하는 경우 증기가 발생할 수 있습니다. 작업장을 환기시키고 필요한 경우 의사와 상담하십시오. 증기가 호흡기를 자극할 수 있습니다.
- ▶ 충전용 배터리는 반드시 제조사가 추천하는 충전기만을 사용하여 충전하십시오. 특정 제품의 충전용 배터리용으로 나온 충전기에 적합하지 않은 충전용 배터리를 충전할 경우 화재 위험이 있습니다.
- ▶ 귀하의 보쉬 측정공구용으로 나온 충전기 배터리만을 사용하십시오. 그래야만이 충전용 배터리가 위험하게 과부하되는 것을 방지할 수 있습니다.
- ▶ 못이나 스크류 드라이버 같은 뾰족한 물체 또는 외부에서 오는 충격 등으로 인해 축전지가 손상될 수 있습니다. 내부 단락이 발생하여 축전지가 타거나 연기가 발생하고, 폭발 또는 과열될 수 있습니다.
- ▶ 배터리 어댑터의 경우 오직 Bosch 측정공구 원래의 용도로만 사용되도록 결정된 것이며, 전동 공구와 함께 사용해서는 안됩니다.
- ▶ 장시간 측정공구를 사용하지 않을 경우에는 배터리를 측정공구에서 빼십시오. 오래 저장할 경우 배터리가 부식되거나 저절로 방전될 수 있습니다.
- ▶ 특히 카메라와 적외선 렌즈 부위를 비롯하여 측정공구가 습기 및 눈에 닿지 않도록 보호하십시오. 수신 렌즈에 김이 서리면 측정 결과가 변조될 수 있습니다. 잘못된 장치 설정과 기타 변수들로 인해 측정 오류가 발생할 수 있습니다. 측정 대상의 온도가 더 높거나 낮게 표시되는 경우도 있으므로, 접촉 시 위험할 수 있습니다.
- ▶ 열상 이미지 내에서도 온도 차이가 커지면 실제로는 높은 온도이지만 낮은 온도의 색상으로 표시될 수 있습니다. 이러한 표면에 접촉하면 화재가 발생할 수 있습니다!
- ▶ 설정한 방사율과 측정 대상의 방사율이 일치할 경우에만 온도가 정확하게 측정됩니다. 측정 대상의 온도 또는 측정 색상이 더 높거나 낮게 표시될 수 있으므로, 접촉 시 위험할 수 있습니다.
- ▶ 주의! 측정공구의 블루투스® 사용은 다른 기기나 설비, 비행기, 그리고 의료기기(예: 심박 조정기, 보청기) 등에 장애를 가져올 수 있습니다. 마찬가지로 직접적인 환경에 있는 동물이나 사람에게도 좋지 않은 영향을 미칠 수 있습니다. 측정공구의 블루투스® 사용은 의료 기기, 주유소, 화학설비, 그리고 폭발 위험이 있는 주변에서는 삼가하십시오. 비행기에서 측정공구의 블루투스® 사용은 삼가하십시오. 오랜 시간 신체에 직접 접촉하여 작동하는 것을 삼가하십시오.
- ▶ 측정공구에는 무선 인터페이스가 장착되어 있습니다. 비행기나 병원 등 장소에 따른 제약에 주의하십시오.

36 | 한국어

제품 및 성능 소개

블루투스® 글자와 그림 (로고) 은 Bluetooth SIG, Inc. 의 등록상표입니다. Robert Bosch Power Tools GmbH 는 허가를 받아 이를 사용하고 있습니다.

규정에 따른 사용

본 측정공구는 표면 온도를 비접촉 방식으로 측정할 수 있도록 고안되었습니다.

표시된 열상 이미지는 적외선 렌즈에 감지된 범위의 온도 분포를 표시하므로, 온도 편차를 다른 색상으로 나타낼 수 있습니다.

따라서 전문적으로 사용하는 경우 표면과 측정 대상의 온도 차이나 온도 정보를 비접촉 방식으로 검사하여, 다음과 같은 부품의 취약 부위를 식별할 수 있습니다.

- 단열재 및 절연재 (열교 감지 등)
- 바닥과 벽 내부에서 작동되는 온수관 (바닥 난방 등)
- 과열된 전기 부품 (퓨즈 또는 단자 등)
- 기기 부품 (볼베어링 결합에 의한 과열 등)

사람이나 동물의 체온을 재거나, 기타 의학적 용도로는 본 측정공구를 사용할 수 없습니다.

본 측정공구는 기체나 액체의 표면 온도 측정에는 적합하지 않습니다.

제품의 주요 명칭

제품의 주요 명칭에 표기되어 있는 번호는 측정공구의 그림이 나와있는 면을 참고하십시오.

- 1 실화상 카메라 및 적외선 센서용 보호 캡
- 2 일련 번호
- 3 마이크로 USB 단자 커버
- 4 마이크로 USB 단자 커버
- 5 위쪽 화살표 버튼
- 6 측정 기능 버튼 "Func"
- 7 온도 눈금 변경 자동 고정 / 우측 기능 버튼
- 8 우측 화살표 버튼

- 9 전원 버튼
- 10 아래쪽 화살표 버튼
- 11 저장 버튼
- 12 좌측 화살표 버튼
- 13 갤러리 버튼 / 좌측 기능 버튼
- 14 디스플레이
- 15 실화상 카메라
- 16 적외선 센서 범위
- 17 측정 버튼 잠금 설정 / 계속 측정
- 18 배터리 슬롯
- 19 충전용 배터리 / 배터리 어댑터 잠금해제 버튼
- 20 배터리 어댑터 실링캡*
- 21 배터리 어댑터 캡*
- 22 캡의 슬롯
- 23 배터리*
- 24 마이크로 USB 케이블
- 25 안전 케이스*

*도면이나 설명서에 나와 있는 액세서리는 표준 공급부품에 속하지 않습니다.

디스플레이 내용

- a 날짜 / 시간
- b 측정 기능
- c 방사율 표시
- d 블루투스® 연결 표시기
- e WiFi 표시 켜짐 / 꺼짐
- f 충전 상태 표시기
- g 측정 범위 내 최고 표면 온도 표시
- h 스케일
- i 측정 범위 내 최저 표면 온도 표시
- j 스케일 잠금 표시
- k 열점 표시 (예시)
- l 온도 표시 십자선
- m 냉점 표시 (예시)
- n 갤러리 아이콘

제품 사양

열 감지 카메라	GTC 400 C
제품 번호	3 601 K83 1..
적외선 센서 해상도	160 x 120
열 민감도	< 50 mK
스펙트럼 영역	8-14 μm
시야 (FOV)	53 x 43°
초점 거리	≥ 0.3 m
포커스	고정 된
표면 온도 측정 범위	-10...+400 °C

귀하의 측정공구를 정확히 식별하려면 타입 표시판에 나와있는 일련 번호 2를 확인하십시오.

- 1) 주변 온도 20-23 °C 및 방사율 > 0.999, 측정 간격: 0.3 m, 작동 시간: > 5 분
 - 2) 온도가 0 °C 보다 낮은 경우 성능 제한 있음
- 기계 사양은 함께 공급되는 배터리를 사용한 경우입니다.

열 감지 카메라		GTC 400 C
측정 정확도 (표준)		
표면 온도¹⁾		
-10...+10 °C		±3 °C
10...100 °C		±3 °C
>+100 °C		±3 %
디스플레이 타입		TFT
디스플레이 사이즈		3.5"
디스플레이 해상도		320 x 240
이미지 포맷		.jpg
메모리당 저장된 이미지		1 x 열상 이미지 (스크린샷) 1 x 가상 이미지 (메타 데이터)
내부 이미지 메모리에 있는 이미지 수 (표준)		500
내장된 가상 카메라		●
배터리 (알칼리 망간)		4 x 1.5 V LR6 (AA) (배터리 어댑터 포함)
충전용 배터리 (리튬 이온)		10.8 V/12 V
USB 연결부		1.1
에너지 공급 TrackMyTools- 블루투스® 모듈		
- 동전형 배터리		CR2450 (3V 리튬 배터리)
- 배터리 수명 약		60 개월
블루투스®		블루투스® 4.2 (Low Energy)
블루투스® 최대 송신 출력		3.2 mW
주파수 대역 블루투스®		2.402-2.480 GHz
무선 연결성		WiFi
WiFi 최대 송신 출력		30 mW
WiFi 작동 주파수 범위		2.400-2.483 GHz
EPTA 공정 01:2014 에 따른 중량		0.54 kg
크기 (길이 x 너비 x 높이)		233 x 95 x 63 mm
안전 등급 (배터리 케이스 제외)		IP 53
허용되는 주변 온도		
- 보관 온도		0...+45 °C
- 작동 온도 ²⁾		-10...+45 °C
- 보관 온도		-20...+70 °C
- 상대 습도 (비응축)		20...80 %
권장 배터리		GBA 10,8 V GBA 12 V
권장하는 충전기		AL 11.. CV GAL 12.. CV

귀하의 측정공구를 정확히 식별하려면 타입 표시판에 나와있는 일련 번호 **2** 를 확인하십시오.

1) 주변 온도 20-23 °C 및 방사율 >0.999, 측정 간격: 0.3 m, 작동 시간: >5 분

2) 온도가 0 °C 보다 낮은 경우 성능 제한 있음

기계 사양은 함께 공급되는 배터리를 사용한 경우입니다.

38 | 한국어

조립

에너지 공급

본 측정공구는 일반 배터리 (AA 배터리 LR6 타입 또는 유사 제품) 또는 부쉬 리튬이온 배터리를 통해 작동이 가능합니다.

**배터리 어댑터를 사용한 작동 (탈착 가능)
(그림 A 참조)**

배터리를 배터리 어댑터에 삽입합니다.

▶ **배터리 어댑터의 경우 오직 Bosch 측정공구 원래의 용도로만 사용되도록 결정된 것이며, 전통 공구와 함께 사용해서는 안됩니다.**

배터리를 **삽입하려면** 배터리 어댑터 캡 21 을 충전용 배터리 슬롯 18 로 밀어 넣으십시오. 그림에 제시된 바와 같이 씰링캡 20 에서 배터리를 삽입하십시오. 캡이 맞물려 끼워지는 느낌이 들고 측정공구의 손잡이에 맞닿을 때까지 씰링캡을 케이스 위로 미십시오.

 배터리를 **분리하려면** 씰링캡 20 의 잠금 해제 버튼 19 를 누르고 씰링캡을 빼내십시오. 이때 배터리가 빠지지 않도록 주의하십시오. 배터리 슬롯 18 이 위쪽을 향하도록 측정공구를 두십시오. 배터리를 탈착합니다. 배터리 슬롯 18 에서 안쪽에 있는 캡 21 을 빼낼 때는 캡의 슬롯 22 를 잡고 약간의 힘을 가해 측정공구 옆으로 빼냅니다 (그림 B 참조).

참고: 캡이 파손될 위험이 있으므로 배터리를 분리할 때 공구 (스크류 드라이버 등) 를 사용하지 마십시오. 항상 배터리를 모두 동시에 교환해 주십시오. 반드시 제조사의 동일한 용량의 배터리를만 사용하십시오.

▶ **장시간 측정공구를 사용하지 않을 경우에는 배터리를 측정공구에서 빼십시오.** 오래 저장할 경우 배터리가 부식하거나 저절로 방전될 수 있습니다.

충전용 배터리를 사용한 작동 (그림 C 참조)

참고: 측정공구에 적합하지 않은 충전용 배터리의 사용은 측정공구의 오류나 손상을 가져올 수 있습니다.

참고: 충전용 배터리는 부분 충전되어 출고됩니다. 충전용 배터리의 완전한 성능을 보장하기 위해서는, 처음 사용하시기 전에 충전기로 충전용 배터리를 완전히 충전하십시오.

▶ **기술자료에 기재되어 있는 충전기만 사용하십시오.** 측정공구에 사용된 리튬이온 배터리에는 이 충전기들만 사용할 수 있습니다.

리튬 이온 충전용 배터리는 언제나 재충전을 할 수 있으며, 수명에 영향을 주지 않습니다. 충전시 중단 하더라도 충전용 배터리는 손상되지 않습니다.





▶ **측정공구의 전원이 자동으로 꺼진 후에는 전원 버튼을 누르지 마십시오.** 배터리가 손상될 수 있습니다.

충전한 배터리 23 을 **삽입하려면** 이 배터리가 맞물려 고정되는 것이 느껴지고 측정공구의 손잡이에 정확히 위치할 때까지 충전용 배터리 슬롯 18 로 미십시오.

충전용 배터리 23 을 **분리하려면** 잠금해제 버튼 19 를 누르고 배터리 슬롯 18 에서 충전용 배터리를 빼내십시오. **무리하게 힘을 가하지 마십시오.**

충전상태 표시판

디스플레이에서 충전상태 표시기 f 는 배터리 또는 충전용 배터리 23 의 충전 상태를 보여줍니다.

표시	용량
	>2/3
	≤2/3
	≤1/3
	≤10%
	배터리 또는 충전용 배터리 교체

작동

▶ **측정공구가 물에 젖거나 직사 광선에 노출되지 않도록 하십시오.**

▶ **측정공구를 극심한 온도에서 혹은 온도 변화가 심한 곳에서 사용하지 마십시오.** 예를 들면 측정공구를 자동차 안에 장기간 두지 마십시오. 온도 변화가 심한 경우 측정공구를 사용하기 전에 우선 적당한 온도가 되도록 하십시오. 극심한 온도에서나 온도 변화가 심한 환경에서 사용하면 측정공구의 정확도가 떨어질 수 있습니다.

▶ **측정공구가 주변 온도와 환경에 제대로 적응되었는지 확인하십시오.** 온도 차이가 심하거나 대기조건의 변화가 심한 경우 다시 적응이 될 때까지 측정의 정확성이 떨어질 수 있습니다.

▶ **측정공구가 외부와 세계 부딪히거나 떨어지지 않도록 주의하십시오.** 외부로부터 강한 충격을 받았거나, 기능적인 측면에 이상이 발생했다면, Bosch 공식 고객 서비스센터에 측정공구의 점검을 의뢰하는 것이 좋습니다.

기계 시동

스위치 커기 / 끄기

측정하려면 보호 캡 1 을 젖혀서 여십시오. **작업하는 동안 적외선 측정 범위가 막히거나 가려지지 않도록 주의하십시오.**

측정공구의 **전원을 켜려면** 전원 버튼 9 를 누르십시오. 디스플레이 14 에서 시작 진행 단계가 나타납니다. 작동 시작 후 곧바로 측정이 시작되고, 기기의 전원을 끌 때까지 측정이 계속 진행됩니다.

참고: 처음 몇 분간은 센서 온도와 주변 온도가 맞지 않아 측정공구의 자동 교정이 평소보다 오래 진행될 수 있습니다. 캘리브레이션 재조정으로 정밀한 측정이 가능합니다. 캘리브레이션이 진행되는 동안 열상 이미지는 잠시 잠금 설정됩니다.

측정공구의 **전원을 끄려면** 전원 스위치를 다시 누르십시오. 모든 설정 내역이 저장된 뒤 전원이 꺼집니다. 측정공구를 안전하게 운반할 수 있도록 보호 캡 1 을 닫으십시오.

설정 메뉴에서 측정공구 전원의 자동 차단 기능 및 차단 시간을 선택할 수 있습니다 (“스위치 오프 시간” 참조, 41 페이지).

충전용 배터리 또는 측정공구가 기술자료에 제시된 작동 온도의 범위를 벗어나면, 측정공구는 짧게 경고 (“고장의 원인과 해결 방법” 참조, 42 페이지) 한 후 자동으로 꺼집니다. 측정공구가 온도에 적응할 시간을 주고 스위치를 다시 켜십시오.

측정 준비

표면 온도 측정을 위한 방사율 설정

대상체의 방사율은 소재와 그 표면의 구조에 따라 달라 집니다. 대상체가 (동일한 온도의 다른 대상체와 비교 해서) 적외선 열방출을 얼마나 많이 혹은 적게 발산하는지를 나타냅니다.

표면 온도를 확인하기 위해 목표 대상이 발산하는 자연 적외선 열방출이 비접촉 방식으로 측정됩니다. 정확한 측정을 위해 측정공구에 설정된 방사율을 **측정할 때마다** 점검하고, 경우에 따라 측정 대상에 맞게 변경해야 합니다.

사전 설정된 방사율을 선택하거나 정확한 값을 입력하면 됩니다. 메뉴 “**측정**” > “**방사율**” 을 통해 원하는 방사율을 설정하십시오 (40 페이지 참조).

▶ 설정한 방사율과 대상의 방사율이 일치할 때만 온도가 정확하게 측정됩니다.

서로 다른 온도 차이 및 방사율로 인해 색상에 차이가 있을 수 있습니다. 방사율 차이가 심한 경우 표시된 온도 차이가 실제 상황과 현저히 다를 수 있습니다.

측정 범위 내에 소재나 구조가 다른 다수의 측정 대상들이 있는 경우 표시된 온도값은 설정된 방사율에 해당하는 대상에만 적용됩니다. 그밖의 (다른 방사율을 갖는) 모든 대상들은 표시된 색상 구분을 통해 온도 관계를 알 수 있습니다.

작업 소재	방사율 (기준값 0 °C...100 °C)
콘크리트	0.93
플라스터 / 모르타르	0.93
벽돌	0.93
루핑 펠트	0.93
라디에이터 도장	0.93
목재	0.91
리놀륨	0.88
종이	0.89

측정 조건에 관한 지침

표면이 강하게 반사되거나 빛나는 경우 (광택 타일 또는 코팅되지 않은 금속 등) 표시된 결과에 영향을 주거나 결과가 변조될 수 있습니다. 경우에 따라 측정 표면에 열전도가 잘 되는 어두운 색의 무광택 접착 테이프를 부착하여 주십시오. 테이프가 표면 온도에 적응할 시간을 줍니다.

표면이 반사되는 경우 적절한 측정 각도를 확인하여 반사된 열 방사가 다른 물체로 인해 변조되지 않도록 하십시오. 예를 들어 앞에서 직각으로 측정할 때 본인의 신체 열이 반사되어 측정에 영향을 줄 수 있습니다. 평면에서는 본인 신체의 윤곽선과 온도가 표시될 수도

있으며 (반사값), 이는 측정되는 표면의 원래 온도 (측정된 값 또는 표면의 실제값) 와 맞지 않습니다. 투명한 소재 (예 : 유리 또는 투명 플라스틱) 를 관통하는 측정은 원칙적으로 불가능합니다.

측정 조건이 안정적이고 우수할수록, 정확하고 신뢰할 만한 결과를 얻을 수 있습니다.

적외선 온도 측정 시 스모그, 증기 / 높은 습도, 공기 내 먼지로 인해 영향을 받을 수 있습니다.

측정의 정확성을 높이기 위한 지침 :

- 본인과 측정 표면 간의 교란 요인을 최소화하기 위해 측정 대상 쪽으로 최대한 가까이 가십시오.
- 특히 공기가 오염되거나 증기가 많은 경우, 측정 전에 공간을 환기시켜 주십시오.
- 환기 후 잠시 평상시 온도를 되찾을 때까지 온도 적응시간을 두십시오.

눈금에 따른 온도 배정

디스플레이 우측에 눈금이 표시됩니다. 위쪽과 아래쪽 끝에 있는 값들은 열상 이미지 내에 감지된 최고 온도 또는 최저 온도를 가리킵니다. 이미지에서 온도값에 따른 색상 할당은 균등하게 이뤄집니다 (직선적).

서로 다른 색상을 사용해 이 두 경계값 내에서 온도가 배정됩니다. 예를 들어 정확히 최대값과 최소값의 가운데에 있는 온도는 눈금의 중간 색상 범위에 배정될 수 있습니다.

특정 영역의 온도를 확인하려면 온도 표시 사진 I 이 원하는 위치나 영역에 오도록 측정공구를 움직이십시오.

자동 설정에서는 눈금의 색상 스펙트럼이 최고 온도나 최저 온도 내에서 전체 측정 범위에 직선적으로 (균등하게) 할당됩니다.

열 감지 카메라는 측정 범위 내 모든 측정 온도를 상대적으로 표시합니다. 예를 들어 하나의 색 표시 범위 내에서 열이 색상표에 푸른색으로 표시된다면 푸른색 영역들은 현재 측정 범위 내에서 더 차가운 값에 속합니다. 그렇지만 이 영역들은 경우에 따라 부상을 입을 수도 있는 높은 온도 범위에 있을 수도 있습니다. 따라서 눈금이나 십자선에 직접 표시된 온도에 항상 주의하십시오.



기능

색 표시 조정

각 측정 상황에 따라 서로 다른 색상표로 열상 이미지를 더욱 쉽게 분석하고 측정 대상이나 환경을 정확하게 디스플레이에 표시할 수 있습니다. 이때 측정 온도에는 영향을 주지 않습니다. 온도값 표시만 달라집니다.

색상표를 변경하려면 측정 모드 상태에서 우측 화살표 버튼 **8** 또는 좌측 화살표 버튼 **12** 를 누르십시오.

40 | 한국어

열상 이미지와 실상 이미지의 중첩

더 나은 설정 (= 표시된 열상 이미지의 공간 배정) 을 위해 조정된 온도 범위에 추가로 시각적 실상 이미지를 활성화할 수 있습니다.

주의: 실상 이미지와 열상 이미지의 중첩은 거리가 0.55 m 일 때 정확하게 이루어집니다. 측정 대상과의 거리가 멀어지면 실상 이미지와 열상 이미지가 서로 일치하지 않을 수 있습니다.

열 감지 카메라에는 다음과 같은 기능들이 있습니다.

- **100% 적외선 사진**

열상 이미지만 표시합니다.

- **화면 속 화면**

표시된 열상 이미지를 삭제하고 주변 영역에 실상 이미지를 표시합니다. 이 설정은 측정 범위의 공간 배정을 개선시킵니다.

- **투시성**

표시된 열상 이미지가 실상 이미지 위에 반 투시적으로 포개지기 때문에 보다 쉽게 대상을 식별할 수 있습니다.

왼쪽 화살표 버튼 **5** 또는 아래쪽 화살표 버튼 **10** 을 눌러 설정을 조정할 수 있습니다.

눈금 고정

열상 이미지 내 색상 분포 조정은 자동으로 진행되지만, 우측 기능 버튼 **7** 을 눌러서 잠금 설정할 수 있습니다. 이렇게 하면 서로 다른 온도 조건에서 촬영된 열상 이미지들을 비교할 수 있습니다 (예: 열교의 여러 부위를 점검할 경우).

스케일을 다시 자동으로 활성화하려면 우측 기능 버튼 **7** 을 다시 누르십시오. 온도가 다시 본래 상태로 돌아오고 측정된 최소값과 최대값에 맞추어 조정됩니다.

측정 기능 버튼

기타 디스플레이와 관련된 편의 기능들을 불러오려면 버튼 **“Func” 6** 을 누르십시오. 표시된 옵션에서 좌측/우측 버튼을 이용해 탐색하며 기능을 선택하십시오. 원하는 기능을 선택하고 버튼 **“Func” 6** 을 다시 누르십시오.

다음과 같은 측정 기능을 사용할 수 있습니다.

- **“자동”**

열상 이미지 내 색상 분포 조정이 자동으로 이뤄집니다

- **“열 탐색”**

이 기능은 측정 범위 내에서 상대적으로 높은 온도만 열상 이미지로 표시합니다. 높은 온도 범위를 벗어난 영역은 실상 이미지에 흑백으로 표시하여 유색 대상과 온도가 잘못 연결되는 일이 없도록 합니다 (예: 과일 부품 탐색 시 배전반의 적색 케이블). 위쪽 버튼 **5** 와 아래쪽 버튼 **10** 을 눌러 눈금을 조정하십시오. 이렇게 해서 제시된 온도 범위를 넓히거나 줄일 수 있습니다.

공구가 최저 온도와 최고 온도를 지속적으로 측정하여 스케일 끝부분에 표시합니다. 그렇지만 특정 온도 범위를 열상 이미지의 유색으로 표시할지는 직접 설정할 수 있습니다.

- **“냉열 탐색”**

이 기능은 측정 범위 내에서 상대적으로 낮은 온도만 열상 이미지로 표시합니다. 낮은 온도를 벗어난 영역은 실상 이미지에 흑백으로 표시하여 유색 대상과 온도가 잘못 표시되는 일이 없도록 합니다 (예: 손상된 단열재 탐색 시 파란색 창틀). 위쪽 버튼 **5** 및 아래쪽 버튼 **10** 을 이용하여 스케일을 조정하십시오. 이렇게 해서 제시된 온도 범위를 넓히거나 줄일 수 있습니다.

공구가 최저 온도와 최고 온도를 지속적으로 측정하여 스케일 끝부분에 표시합니다. 그렇지만 특정 온도 범위를 열상 이미지의 유색으로 표시할지는 직접 설정할 수 있습니다.

- **“수동”**

열상 이미지 내에 측정된 온도의 차이가 심하면 (예: 열교 탐색 시 뜨거운 대상인 라디에이터) 최고 온도와 최저 온도 사이에 많은 온도 값들이 제공된 색상으로 배정됩니다. 이때 미세한 온도 차이는 세부적으로 표시되지 않을 수 있습니다. 초점 온도를 상세히 표시하려면 다음과 같이 하십시오. **“수동”** 모드로 바꾼 뒤 최고 온도 또는 최저 온도를 조정할 수 있습니다. 이렇게 해서 미세한 차이를 알고자 하는 온도의 범위를 설정할 수 있습니다. **Reset** 설정을 통해 스케일을 다시 자동으로 적외선 센서 가시 영역의 측정값에 맞출 수 있습니다.

시작 메뉴

시작 메뉴로 들어가려면, 측정 기능을 불러오는 버튼 **“Func” 6** 을 누르십시오. 우측 기능 버튼 **7** 을 누르십시오.

- **“측정”**- **“방사율” c:**

가장 자주 사용하는 소재 중 일부는 저장되어 있는 방사율을 선택할 수 있습니다. 메뉴항목 **“소재”** 에서 해당 소재를 선택하십시오. 해당 방사율은 한 행 밑에 제시됩니다.

측정 대상의 방사율을 정확히 알고 있는 경우, 메뉴항목 **“방사율”** 에 이 값을 숫자로도 설정할 수 있습니다.

- **“반사 온도”:**

이 작동 변수를 설정하면 특히 낮은 방사율 (= 높은 반사) 을 갖는 소재에서 측정 결과가 향상됩니다. 대부분 반사 온도는 주변 온도에 일치합니다.

온도 차이가 심한 대상들이 강하게 반사되는 대상들 가까이에서 측정에 영향을 미칠 수 있다면 이 값을 조정해야 합니다.

- **“디스플레이”**- **“열점” k: “커짐 / 꺼짐”**

이 기능은 측정 범위 내에서 가장 뜨거운 점 (= 측정 픽셀) 을 적색 십자선으로 자동 표시합니다. 이를 통해 배전반의 느슨해진 단자 등에서 위험 부위를 더욱 쉽게 찾을 수 있습니다.

- “**냉점**” m: “**켜짐 / 꺼짐**”

측정 범위 내에서 가장 차가운 점 (= 측정 픽셀) 이 열상 이미지에 파란색 십자선으로 자동 표시됩니다. 이를 통해 절연재의 누설 부위와 같은 위험 부위를 더욱 쉽게 찾을 수 있습니다.

- “**십자선**” l: “**켜짐 / 꺼짐**”

십자선은 열상 이미지의 중심부에 표시되며 이 부위의 측정 온도값을 표시합니다.

- “**스케일**” h: “**켜짐 / 꺼짐**”

- “**WiFi**”: “**켜짐 / 꺼짐**”

(“데이터 전송” 참조, 41 페이지)

- “**Track My Tools**”: “**켜짐 / 꺼짐**”

(“TrackMyTools” 참조, 43 페이지)

- “**장치**”

- “**언어**”

이 메뉴 항목에서 모든 디스플레이 언어를 조정할 수 있습니다.

- “**시간 & 날짜**” a

표시기에서 날짜와 시간을 변경하려면 하위메뉴 “**시간 & 날짜**” 를 불러오십시오. 그 외에도 날짜 및 시간 형식을 바꿀 수 있습니다.

하위메뉴 “**시간 & 날짜**” 를 끝내려면 체크 표시 아래에 위치한 좌측 기능 버튼 **13** 을 눌러 설정 내용을 저장하거나 또는 십자 표시 아래에 위치한 우측 기능 버튼 **7** 을 눌러 변경 사항을 취소하십시오.

- “**신호음**”: “**켜짐 / 꺼짐**”

이 메뉴항목에서 신호음을 켜고 끌 수 있습니다.

- “**스위치 오프 시간**”

이 메뉴 항목에서 아무런 버튼을 누르지 않을 경우 측정공구가 자동으로 꺼지는 시간 주기를 선택할 수 있습니다. 설정에서 “**끄지않기**” 을 선택하면 자동 차단 기능을 비활성화할 수도 있습니다.

- “**모든 이미지 삭제**”

이 메뉴항목에서 내부 메모리에 있는 모든 파일을 한 번에 삭제할 수 있습니다. 해당 하위메뉴로 들어가려면, “**더보기 ...**” 에 해당하는 우측 화살표 버튼 **8** 을 누르십시오. 모든 파일을 삭제하려면 체크 표시 아래에 위치한 좌측 기능 버튼 **13** 을 누르고, 과정을 취소하려면 십자 표시 아래에 위치한 우측 기능 버튼 **7** 을 누르십시오.

- “**장치 정보**”

이 메뉴 항목에서 측정공구에 관한 모든 정보를 불러올 수 있습니다. 측정공구의 제품 번호 및 설치된 소프트웨어 버전을 확인할 수 있습니다.

임의의 메뉴를 끝내고 일반 디스플레이 화면으로 돌아가려면, 측정 버튼 **17** 을 누르십시오.

측정 결과 문서 작업

측정 결과 저장하기

스위치를 켜 후 곧바로 측정이 시작되고 스위치를 끄때까지 측정이 계속 진행됩니다.

이미지를 저장하려면 카메라를 원하는 측정 대상 쪽으로 향하게 하고 저장 버튼 **11** 를 누르십시오. 이미지

가 카메라의 내부 메모리에 저장됩니다. 또 다른 방법으로는 측정 잠금 설정 버튼 **17** 을 누르십시오. 측정이 잠금 설정되고 디스플레이에 표시됩니다. 이렇게 하면 방해 없이 화면을 볼 수 있습니다. 잠금 설정된 화면을 저장하지 않으려면 버튼 **17** 을 눌러 다시 측정 모드로 들어갑니다. 카메라의 내부 메모리에 이미지를 저장하려면, 저장 버튼 **11** 를 누르십시오.

저장한 이미지 불러오기

저장한 열상 이미지를 불러오려면 다음과 같이 하십시오.

- 좌측 기능 버튼 **13** 을 누르십시오. 디스플레이에 마지막으로 저장한 화면이 나타납니다.
- 저장한 열상 이미지 사이에서 전환하려면 우측 화살표 버튼 **8** 또는 좌측 화살표 버튼 **12** 를 누르십시오.

저장한 이미지 삭제하기

개별 열상 이미지를 삭제하려면 갤러리 뷰로 가십시오:

- 휴지통 아이콘 아래에 있는 우측 기능 버튼 **7** 을 누르십시오.
- 확인을 위해 좌측 기능 버튼 **13** 을 누르거나 삭제를 중단하려면 중단하기 아이콘 아래에 있는 기능 버튼 **7** 을 누르십시오.

모든 이미지 삭제

메뉴 “**모든 이미지 삭제**” 에서 내부 메모리에 있는 모든 파일을 한번에 삭제할 수 있습니다.

“**Func**” **6** 버튼을 눌러 측정 기능을 불러오십시오. 우측 기능 버튼 **7** 을 눌러 “**장치**” > “**모든 이미지 삭제**” 를 선택하십시오. 우측 화살표 버튼 **8** 을 누르면, 해당 하위메뉴로 들어갑니다. 모든 파일을 삭제하려면 체크 표시 아래에 위치한 좌측 기능 버튼 **13** 을 누르고, 삭제를 취소하려면 십자 표시 아래에 위치한 우측 기능 버튼 **7** 을 누르십시오.

데이터 전송

USB 인터페이스를 통한 데이터 전송

마이크로 USB 단자 캡 **3** 을 여십시오. 측정공구의 마이크로 USB 단자를 함께 공급된 마이크로 USB 케이블을 이용하여 컴퓨터 또는 노트북에 연결하십시오.

버튼 **9** 를 사용해 열 감지 카메라의 전원을 켜십시오. 파일 브라우저를 열고 드라이브 “**BOSCH**

GTC 400 C” 를 선택하십시오. 저장한 JPG 파일은 측정공구의 내부 메모리에서 복사, 이동 또는 삭제할 수 있습니다.

원하는 과정이 끝나면 정상적으로 드라이브를 분리하고 버튼 **9** 를 사용해 열 감지 카메라의 전원을 다시 끄십시오.

측정 작동 중에는 마이크로 USB 케이블을 빼고 캡 **3** 을 닫으십시오.

주의: 먼저 운영 시스템에서 드라이브를 분리하십시오 (드라이브 꺼내기). 열 감지 카메라의 내부 메모리가 손상될 수 있습니다.

케이스에 먼지나 물이 들어가지 않도록 USB 인터페이스는 항상 캡을 닫아 두십시오.

42 | 한국어

주의: 측정공구는 컴퓨터나 노트북에만 연결하십시오. 다른 기기와 연결할 경우 공구가 손상될 수도 있습니다.
주의: 마이크로 USB 인터페이스는 데이터 전송에만 사용되며 배터리와 충전지를 충전하는데 사용할 수 없습니다.

열상 이미지 재작업

저장한 열상 이미지를 컴퓨터 윈도우 시스템에서 재작업할 수 있습니다. 이를 위해 www.bosch-professional.com/gtc 를 방문해 열 감지 카메라 제품 페이지에서 GTC-Transfer-Software 를 다운로드 받으십시오.

WiFi 을 통한 데이터 전송

측정공구에는 WiFi 모듈이 장착되어 있어서 열 감지 카메라에 저장한 이미지를 모바일 단말기에 무선으로 전송할 수 있습니다.
 이를 위해 소프트웨어 인터페이스에 해당하는 **“Measuring Master”** 애플리케이션이 필요합니다. 단말기에 따라 해당 스토어에서 다운로드 받으실 수 있습니다:



“Measuring Master” 를 사용하면 이미지를 무선으로 전송할 수 있을 뿐만 아니라 기능의 범위가 넓어지고 재작업과 측정 데이터 전달 (이메일을 통한 전달 등) 이 간편해집니다. WiFi 연결에 필요한 시스템 조건에 관한 정보는 보쉬 인터넷 사이트 **“www.bosch-professional.com/gtc”** 에서 확인할 수 있습니다.

측정공구에서 WiFi 연결을 활성화/비활성화시키려면, 메인 메뉴를 불러온 후 **“WiFi”** 선택할 수 있는 버튼을 탐색하여 연결을 활성화/비활성화하십시오. 디스플레이에 표시 **e** 가 나타납니다. 모바일 단말기에 있는 와이파이 인터페이스가 활성화되었는지 확인하십시오. 보쉬 애플리케이션을 시작하면 (WiFi 모듈이 활성화된 상태에서) 모바일 단말기와 측정공구 사이에 연결이 생성됩니다. 이를 위해 **“Measuring Master”** 사용 지침을 따르십시오.

고장의 원인과 해결 방법

장애 발생 시 장치를 다시 시작하면 연결 상태에서 다시 사용할 수 있습니다. 그밖에 계속해서 오류 메시지가 뜨는 경우 아래의 내용을 참고하십시오.

고장	원인	해결 방법
측정공구가 켜지지 않습니다.	충전용 배터리 또는 배터리 비어 있음	충전용 배터리를 충전하거나 배터리를 교환하십시오.
	충전용 배터리 너무 뜨거움 또는 너무 차가움	충전용 배터리가 온도에 적응할 시간을 주거나 배터리를 교환하십시오.
	측정공구 너무 뜨거움 또는 너무 차가움	측정공구가 온도에 적응할 시간을 주십시오.
	이미지 메모리 이상 있음	모든 이미지를 삭제하여 내부 메모리를 포맷하십시오 (“모든 이미지 삭제” 참조, 41 페이지). 계속해서 문제가 존재하면, 측정공구를 공인된 보쉬 서비스센터에 보내십시오.
	이미지 메모리 꽉 참	필요에 따라 이미지를 다른 저장 매체 (예: 컴퓨터 또는 노트북) 로 옮기십시오. 그리고 나서 내부 메모리의 이미지를 전송하십시오.
	측정공구 결함	측정공구를 공인된 보쉬 서비스센터에 보내십시오.
	측정공구를 컴퓨터에 연결할 수 없습니다.	측정공구가 컴퓨터에 인식되지 않음. 마이크로 USB 연결 또는 마이크로 USB 케이블 결함

개념 설명

적외선 열 방출

적외선 열 방출은 각 본체에서 발산되는 전자기적 방출입니다. 방출량은 온도 및 본체의 방사율에 따라 달라집니다.

방사율

대상체의 방사율은 소재와 그 표면의 구조에 따라 달라집니다. 이상적인 방열기 (흑색 바다, 방사율 $\epsilon=1$) 와 대비 해당 대상이 발산하는 적외선 열 방출이 얼마나 되는지 제시합니다.

열교

의도치 않게 열을 바깥쪽 또는 안쪽으로 통과시켜 벽의 나머지 온도 또는 원하는 온도와 크게 차이가 나는 물체를 열교라 칭합니다.

열교의 표면 온도가 일반 공간에서보다 낮기 때문에, 이곳에서의 곰팡이 발생 위험은 현저하게 높아집니다.

반사 온도 / 대상의 반사열 작용

반사 온도는 대상 자체에서 나오지 않는 열 방출입니다. 구조와 소재에 따라 주변 복사열이 측정 대상 내에서 반사되며 이로 인해 실제 온도 결과가 변조됩니다.

대상 간격

측정 대상과 측정공구 사이의 간격은 화소 당 감지되는 면적에 영향을 줍니다. 대상 간격을 늘리면 감지할 수 있는 대상의 크기도 점점 커집니다.

거리 (m)	적외선 화소 크기 (mm)	적외선 범위 폭 x 높이 (m)
0.5	3	~0.5x0.4
1	6	~1x0.75
2	12	2.05x1.5
5	30	5.1x3.8

TrackMyTools

설치된 블루투스® Low Energy Module 은 블루투스® 무선 기술에 기반하여 측정공구의 사용자 개별 설정, 상태 점검과 측정 설정 내역 및 데이터 전송이 가능합니다.

에너지 공급 TrackMyTools- 블루투스® 모듈

측정공구에는 동전형 배터리가 장착되어 있어서 충전지 23 또는 배터리가 끼워져 있지 않아도 TrackMyTools 을 통해 모바일 단말기로 감지할 수 있습니다.

보다 상세한 정보는 보쉬 앱에서 직접 확인할 수 있습니다.

데이터 전송

TrackMyTools- 블루투스® 모듈은 장치 설정에서 활성화 또는 비활성화 할 수 있습니다. 그 다음에는 지속적인 신호를 내보냅니다.

모듈의 전송 주기는 8 초입니다. 환경에 따라 측정공구가 감지되기 전까지 세 번의 전송 주기를 거쳐야 할 수 있습니다.

참고: 기내에서와 같이 전자파 발신이 금지된 장소에 머무는 경우 TrackMyTools 를 비활성화하십시오.

앱 / 웹 애플리케이션 등록 및 셋업

TrackMyTools 를 사용하기 위해서는 우선 온라인 회원 가입이 필요합니다.

웹사이트 www.bosch-trackmytools.com 을 열고 회원 가입을 하십시오. 회원 가입 후 접속 데이터를 받게 됩니다.

해당 앱 스토어 (Apple App Store, Google Play Store) 에서 **TrackMyTools** 앱을 다운로드하거나 <https://web.bosch-trackmytools.com> 사이트를 통해 웹 애플리케이션을 다운로드하십시오. 여기에서 접속 데이터로 로그인할 수 있습니다.

이제 앱 / 웹 애플리케이션을 통해 보유하고 있는 제품 목록을 생성하고 관리할 수 있습니다.

참고: 먼저 앱 / 웹 애플리케이션의 지침 전체를 숙지 하십시오. 인벤토리 생성과 소프트웨어 사용에 관한 지침을 이해하는데 도움이 됩니다.

보수 정비 및 서비스

보수 정비 및 유지

측정공구는 항상 정품 포장 상태 또는 보호 커버 (액세서리) 와 같은 적합한 보호 케이스에 담아 보관 및 운반하십시오. 측정공구 적외선 센서 주변에 스티커를 부착하지 마십시오.

항상 측정공구를 깨끗이 유지하십시오.

청소할 때 액체가 측정공구 안으로 들어가지 않도록 하십시오.

뽕족한 물건으로 센서, 카메라 또는 수신 렌즈에 있는 먼지를 제거하려 하지 말고, 카메라 및 수신 렌즈 위쪽으로 닦아내지 마십시오 (스크래치 위험).

측정공구의 캘리브레이션 변경을 원하는 경우 보쉬 서비스 센터로 연락하십시오 (주소는 "보쉬 AS 및 고객 상담" 참조).

수리가 필요한 경우 측정공구를 정품 포장 또는 보호 커버 (액세서리) 에 담아 보내십시오.

내장된 동전형 배터리는 폐기처리를 위해 전문가를 통해서만 분리할 수 있습니다. 하우징 커버를 열면서 측정공구가 파손될 수 있습니다. 하우징의 볼트를 돌려 풀고 하우징 커버를 빼내어 동전형 배터리를 분리하십시오.

보쉬 AS 및 고객 상담

보쉬는 귀하의 제품 및 수리에 관한 문의를 받고 있습니다.

AS 센터 정보 및 제품에 대한 고객 상담은 하기 고객센터 및 이메일 상담을 이용해주시기 바랍니다.

고객 콜센터 : 080-955-0909

이메일 상담 :

Bosch-pt.hotline@kr.bosch.com

문의나 대체 부품 주문 시에는 반드시 제품 네임 플레이트에 있는 10 자리의 부품번호를 알려 주십시오.

44 | ภาษาไทย

Bosch Korea, RBKR
Mechanics and Electronics Ltd.
PT/SAX-ASA
298 Bojeong-dong Giheung-gu
Yongin-si, Gyeonggi-do, 446-913
080-955-0909

운반

사용할 수 있는 이온 리튬 충전용 배터리는 위험물 처리 규정에 따릅니다. 충전용 배터리는 사용자에게 의해 부가적인 규정 없이 거리에 운반할 수 있습니다. 제삼자 (예를 들면, 항공운송이나 운송업체)를 통해 운송할 경우, 포장과 표시에 관한 특별 사항에 대해 유의해야 합니다. 운송 제품을 준비할 때, 위험물 담당 전문가의 참석하에 진행되어야 합니다.

충전용 배터리는 케이스가 손상되지 않았을 때만 운송해야 합니다. 충전용 배터리는 개방된 접촉부들을 봉입하고 상자 내에서 움직이지 않도록 포장해야 합니다. 또한 유효한 국가 규정들을 유의하십시오.

처리



측정공구, 충전용 배터리 / 배터리, 액세서리 및 포장은 친환경적으로 재활용됩니다.



측정공구와 배터리 팩 / 배터리를 가정용 쓰레기로 처리하지 마십시오!

충전용 배터리 / 배터리 :

Li-Ion:

"운반" 내용에 나와 있는 주의 사항을 준수하십시오 (44 페이지).

위 사항은 사전 예고 없이 변경될 수 있습니다.

해당 무선설비는 전파혼신 가능성이 있으므로 인명안전과 관련된 서비스는 할 수 없습니다.

ภาษาไทย

กฎระเบียบเพื่อความปลอดภัย



ต้องอ่านและปฏิบัติตามคำแนะนำทั้งหมด หากไม่ใช้เครื่องมือวัดตรงตามคำแนะนำเหล่านี้ ระบบป้องกันภายในเครื่องมือวัดอาจได้รับผลกระทบเก็บรักษาคำแนะนำเหล่านี้สำหรับใช้อ้างอิงในภายหลัง

- ▶ การซ่อมแซมเครื่องมือวัดควรทำโดยผู้เชี่ยวชาญและใช้อะไหล่เท่านั้น ทั้งนี้เพื่อให้มั่นใจได้ว่าสามารถใช้งานเครื่องมือวัดได้อย่างปลอดภัยเสมอ
- ▶ อย่าใช้เครื่องมือวัดในบรรยากาศที่มีโอกาสระเบิด เช่น ในบริเวณที่มีของเหลวติดไฟได้ แก๊ส หรือฝุ่นละออง ในเครื่องมือวัดสามารถเกิดประกายไฟซึ่งอาจจุดฝุ่นละอองหรือไอระเหยให้ติดไฟได้

▶ ถอดแบตเตอรี่แพ็คหรือแบตเตอรี่ออกก่อนทำการปรับแต่งใดๆ ที่เครื่องมือวัด (ต.ย. เช่น การติดตั้งการบำรุงรักษา และอื่นๆ) รวมทั้งในระหว่างการขนย้าย และเมื่อเก็บเครื่องมือวัดเข้าที่

▶ อย่าเปิดแบตเตอรี่แพ็ค อันตรายจากการลัดวงจร



ปกป้องกันแบตเตอรี่แพ็คจากความร้อน ต.ย. เช่น แสงแดดจัดต่อเนื่อง ไฟ น้ำ และความชื้น



อันตรายจากการระเบิด

▶ เมื่อไม่ใช้แบตเตอรี่แพ็ค ให้เก็บแบตเตอรี่แพ็คไว้ห่างโลหะวัตถุอื่นๆ เช่น คลิปหนีบกระดาษ เหรียญ กุญแจ ตะปู สกรู หรือโลหะวัตถุขนาดเล็กอื่นๆ ที่สามารถต่อขั้วหนึ่งไปยังอีกขั้วหนึ่งได้ การลัดวงจรของขั้วแบตเตอรี่อาจทำให้เกิดการไหม้หรือฟลล็กได้

▶ เมื่อใช้คัตวี่ อาจมีของเหลวไหลออกมาจากแบตเตอรี่แพ็คได้ ให้หลีกเลี่ยงการสัมผัสของเหลว หากสัมผัสโดยบังเอิญ ให้ใช้น้ำล้าง หากของเหลวเข้าตา ให้ขอความช่วยเหลือจากแพทย์ด้วย ของเหลวที่ไหลออกมาจากแบตเตอรี่แพ็คอาจทำให้เกิดอาการคันหรือแสบผิวหนังได้

▶ ในกรณีที่แบตเตอรี่แพ็คชำรุดและใช้แบตเตอรี่แพ็คอย่างไม่ถูกต้อง อาจมีไอระเหยออกมา ให้สูดอากาศบริสุทธิ์ และหาแพทย์ในกรณีเจ็บปวด ไอระเหยอาจทำให้ระบบหายใจระคายเคือง

▶ ชาร์จเข้าด้วยเครื่องชาร์จที่บริษัทผู้ผลิตระบุไว้เท่านั้น เครื่องชาร์จที่เหมาะสมสำหรับชาร์จแบตเตอรี่แพ็คประเภทหนึ่ง หากนำไปชาร์จแบตเตอรี่แพ็คประเภทอื่น อาจเกิดไฟไหม้ได้

▶ ใช้แบตเตอรี่แพ็คเฉพาะกับเครื่องมือไฟฟ้า บ้อช ของท่านเท่านั้น การกระทำเช่นนี้เท่านั้นที่จะช่วยปกป้องแบตเตอรี่แพ็คจากการถูกใช้งานเกินพิกัดซึ่งเป็นอันตราย

▶ แบตเตอรี่แพ็คอาจได้รับความเสียหายจากวัตถุมีคม ต.ย. เช่น ตะปูหรือไขควง หรือแรงกระแทกจากภายนอก สิ่งเหล่านี้ อาจทำให้เกิดการลัดวงจรภายในและแบตเตอรี่ใหม่ มีควัน ระเบิด หรือร้อนเกินไป

▶ แบตเตอรี่อะแคบเคอร์นี้ไม่มีไว้สำหรับใช้ในเครื่องมือวัด บ้อช ที่ออกแบบมาให้ใช้ได้เท่านั้น และต้องไม่นำมาใช้งานกับเครื่องมือไฟฟ้า

▶ เมื่อไม่ใช้งานเป็นเวลานาน ให้นำแบตเตอรี่ออกจากเครื่องมือวัด หากใส่แบตเตอรี่ทิ้งไว้นานๆ แบตเตอรี่จะเกิดการกัดกร่อนและปล่อยประจุไฟฟ้าออกมา

▶ ปกป้องเครื่องมือวัดจากความชื้นและหิมะ โดยเฉพาะอย่างยิ่งบริเวณกล่องและเลนส์อินฟราเรด เลนส์รับอาจเกิดฝ้าและผลการวัดอาจผิดพลาดได้ การตั้งค่าอุปกรณ์อย่างไม่ถูกต้องตลอดจนปัจจัยอื่นๆ ที่มีอิทธิพลต่อบรรยากาศอาจทำให้การวัดผิดพลาดได้ วัตถุอาจร้อนขึ้นหรือเย็นขึ้นได้ ซึ่งอาจเป็นอันตรายเมื่อสัมผัส

▶ ความแตกต่างมาก ๆ ของอุณหภูมิในสภาพความร้อน อาจทำให้อุณหภูมิสูงถูกแสดง ในสิ่งที่เกี่ยวข้องกับอุณหภูมิต่ำ การสัมผัสกับพื้นผิวดังกล่าวอาจทำให้เกิดการไหม้!

- ▶ ท่านสามารถวัดอุณหภูมิได้อย่างถูกต้องหาก คำสั่งประสิทธิภาพแผ่รังสีความร้อนที่ตั้งไว้และ คำสั่งประสิทธิภาพแผ่รังสีความร้อนของวัตถุ สอดคล้องกัน วัตถุอาจถูกแสดงเป็นอุณหภูมิและ/หรือสีที่ ร้อนกว่าหรือเย็นกว่า ซึ่งอาจเป็นอันตรายเมื่อสัมผัส
- ▶ **ระวัง!**การใช้เครื่องมือวัดพร้อม Bluetooth® อาจ กระทบอุปกรณ์และระบบอื่นๆ เครื่องบิน และอุปกรณ์ ทางการแพทย์ (ต.ย. เช่น เครื่องกระตุ้นหัวใจ เครื่อง ช่วยฟัง) นอกจากนี้ยังอาจเกิดความเสียหายต่อคนและ สัตว์ในบริเวณใกล้เคียงด้วยอย่าใช้เครื่องมือวัดพร้อม Bluetooth® ใกล้อุปกรณ์ทางการแพทย์ สถานีบริการ น้ำมัน โรงงานสารเคมี พื้นที่ที่มีบรรยากาศเสี่ยงต่อ การระเบิด และพื้นที่ปฏิบัติการระเบิดอย่าใช้เครื่องมือ วัดพร้อม Bluetooth® ในเครื่องบินหลีกเลี่ยง การทำงานบริเวณใกล้ร่างกายโดยตรงเป็นระยะเว ลานาน
- ▶ เครื่องมือวัดมีอินเทอร์เฟซคลื่นวิทยุสำหรับเชื่อมโยง สื่อสารแบบไร้สายซึ่งคำนึงถึงข้อจำกัดในการทำงาน เฉพาะที่ ต.ย. เช่น ในเครื่องบิน หรือโรงพยาบาล

รายละเอียดผลิตภัณฑ์และ ข้อมูลจำเพาะ

เครื่องหมายคำและโลโก้ Bluetooth® เป็นเครื่องหมาย การค้าจดทะเบียนและเป็นทรัพย์สินของ Bluetooth SIG, Inc. และ Robert Bosch Power Tools GmbH ใช้เครื่องหมายคำ/โลโก้ดังกล่าวโดยได้รับอนุญาตแล้ว

ประโยชน์การใช้งาน

กล้องถ่ายภาพความร้อนนี้ใช้สำหรับวัดอุณหภูมิพื้นผิววัตถุแบบ ไม่สัมผัส

ภาพความร้อนที่แสดงจะบ่งบอกถึงการกระจายของอุณหภูมิ ของพื้นที่ที่เลนส์อินฟราเรดตรวจจับ และด้วยเหตุนี้จึงสามารถ แสดงการเบี่ยงเบนของอุณหภูมิในลักษณะของสีที่แตกต่างกัน ดังนั้นเมื่อใช้งานอย่างถูกต้อง ท่านจะสามารถตรวจพื้นผิว และวัตถุหาความแตกต่างของอุณหภูมิหรือความโดดเด่นของ อุณหภูมิโดยไม่สัมผัส เพื่อให้มองเห็นส่วนประกอบและ/หรือ จุดอ่อนใดๆ รวมทั้ง:

- ฉนวนกันความร้อนและฉนวน (ต.ย. เช่น การค้นพบสะสม พาน ความร้อน)
- ท่อส่งน้ำร้อนและน้ำเย็นที่ทำงานอยู่ (ต.ย. เช่น ระบบทำ ความอุ่นใต้พื้น) ในพื้นและผนัง
- ชิ้นส่วนไฟฟ้าที่ร้อนเกินไป ต.ย. เช่น พิวสหรือแคลมป์
- ชิ้นส่วนเครื่องจักร (ต.ย. เช่น ความร้อนสูงเกินไป เนื่องจากดัดปลุกปืนซาร์ต

อย่าใช้เครื่องมือวัดนี้สำหรับวัดอุณหภูมิที่คนและสัตว์ หรือเพื่อ วัตถุประสงค์ทางการแพทย์อื่นๆ อย่างเด็ดขาด

เครื่องมือวัดนี้ไม่เหมาะสำหรับใช้วัดอุณหภูมิพื้นผิวของก๊าส หรือของเหลว

ส่วนประกอบผลิตภัณฑ์

ลำดับเลขของส่วนประกอบผลิตภัณฑ์อ้างอิงถึงส่วนประกอบของ เครื่องมือวัดที่แสดงในหน้าภาพประกอบ

- 1 ฝาครอบป้องกันสำหรับกล้องมองและเซนเซอร์ อินฟราเรด
- 2 หมายเลขเครื่อง
- 3 ฝาครอบพอร์ตไมโคร USB
- 4 พอร์ตไมโคร USB
- 5 ปุ่มลูกศรชี้ขึ้นข้างบน
- 6 ฟังก์ชันการวัด "Func"
- 7 การเปลี่ยนสเกลอุณหภูมิ อัตโนมัติ-คงที่/ปุ่มฟังก์ชัน ทางขวา
- 8 ปุ่มลูกศรชี้ไปทางขวา
- 9 ปุ่มเปิด-ปิด
- 10 ปุ่มลูกศรชี้ลงข้างล่าง
- 11 ปุ่มบันทึก
- 12 ปุ่มลูกศรชี้ไปทางซ้าย
- 13 ปุ่มแกลเลอร์/ปุ่มฟังก์ชันทางซ้าย
- 14 จอแสดงผล
- 15 กล้องมอง
- 16 อินฟราเรด-ช่วงเซนเซอร์
- 17 ปุ่มหยุดการวัด/วัดต่อไป
- 18 ช่องแบตเตอรี่
- 19 ปุ่มปลดล็อกแบตเตอรี่แพ็ค/แบตเตอรี่อะแดปเตอร์
- 20 ฝาปิดแบตเตอรี่อะแดปเตอร์*
- 21 ปลอกหุ้มแบตเตอรี่อะแดปเตอร์*
- 22 ช่องเข้า ปลอกหุ้ม
- 23 แบตเตอรี่แพ็ค*
- 24 สายไมโคร USB
- 25 กระเป๋าใส่เครื่องมือวัด*

*อุปกรณ์ประกอบในภาพประกอบหรือในคำอธิบาย ไม่รวมอยู่ใน การจัดส่งมาตรฐาน

ชิ้นส่วนแสดงผล

- a วันที่/เวลา
- b ฟังก์ชันการวัด
- c สัญลักษณ์ คำสั่งประสิทธิภาพแผ่รังสี
- d ไฟแสดงการเชื่อมต่อ Bluetooth®
- e ไฟแสดง WiFi เปิด-ปิด
- f สัญลักษณ์การควบคุมการชาร์จ
- g ไฟแสดงอุณหภูมิพื้นผิวสูงสุดในบริเวณวัด
- h สเกล
- i ไฟแสดงอุณหภูมิพื้นผิวต่ำสุดในบริเวณวัด
- j ไอคอนการล็อกสเกล
- k ไฟแสดง จุดร้อน (ตัวอย่าง)
- l กากบาทพร้อมไฟแสดงอุณหภูมิ
- m ไฟแสดง จุดเย็น (ตัวอย่าง)
- n ไอคอนแกลเลอร์

46 | ภาษาไทย

ข้อมูลทางเทคนิค

กล้องถ่ายภาพความร้อน	GTC 400 C
หมายเลขสินค้า	3 601 K83 1..
ความละเอียด เซนเซอร์อินฟราเรด	160 x 120
ความไวการแยกแยะอุณหภูมิ	< 50 mK
ความยาวคลื่นที่ตรวจจับ	8 – 14 µm
มุมมองของภาพ (FOV)	53 x 43°
ระยะโฟกัส	≥ 0.3 ม.
โฟกัส	คงที่
บริเวณวัด อุณหภูมิพื้นผิว	-10...+400 °C
ความแม่นยำการวัด (ปกติ)	
อุณหภูมิพื้นผิว¹⁾	
-10...+10 °C	±3 °C
10...100 °C	±3 °C
>+100 °C	±3 %
ชนิดจอแสดงผล	TFT
ขนาดจอแสดงผล	3.5"
ความละเอียดจอแสดงผล	320 x 240
รูปแบบไฟล์ภาพ	.jpg
ภาพที่จัดเก็บต่อกระบวนการจัดเก็บ	1 x ภาพความร้อน (การจับภาพหน้าจอ) 1 x ภาพจริงที่ตาเห็นรวมทั้งค่าอุณหภูมิ (คำอธิบายข้อมูล)
จำนวนภาพในหน่วยความจำภาพภายใน (ตามปกติ)	500
กล้องมองเบ็ดเสร็จ	●
แบตเตอรี่ (อัลคาไลน์-แมงกานีส)	4 x 1.5 โวลต์ LR6 (AA) (กับแบตเตอรี่อะแดปเตอร์)
แบตเตอรี่แพ็ค (ลิเทียม-ไอออน)	10.8 โวลต์/12 โวลต์
การเชื่อมต่อ USB	1.1
แหล่งจ่ายไฟฟ้า TrackMyTools-Bluetooth®-โมดูล	
- ถ่านกระดุม	CR2450 (แบตเตอรี่ลิเทียม 3-V)
- อายุแบตเตอรี่ ประมาณ	60 เดือน
Bluetooth®	Bluetooth® 4.2 (พลังงานต่ำ)
กำลังส่ง Bluetooth® สูงสุด	3.2 mW
ย่านความถี่ Bluetooth®	2.402 – 2.480 GHz
การเชื่อมต่อ-ไร้สาย	WiFi
กำลังส่ง WiFi สูงสุด	30 mW
ย่านความถี่ใช้งาน WiFi	2.400–2.483 GHz
น้ำหนักตามระเบียบการ-EPTA-Procedure 01:2014	0.54 กก.
ขนาด (ความยาว x ความกว้าง x ความสูง)	233 x 95 x 63 มม.
ระดับการป้องกัน (ยกเว้นแบตเตอรี่)	IP 53
เครื่องมือวัดนี้หมายถึงหมายเลขเครื่อง 2 บนแผ่นป้ายรุ่น	
1) ที่อุณหภูมิล้อมรอบ 20–23 °C และค่าสัมประสิทธิ์การแผ่รังสีความร้อน >0.999 ระยะห่างการวัด: 0.3 m เวลาทำงาน: >5 นาที	
2) ผลการทำงานน้อยลงที่อุณหภูมิ <0 °C	
กำหนดข้อมูลทางเทคนิคด้วยแบตเตอรี่ที่จัดส่งมา	

กล้องถ่ายภาพความร้อน	GTC 400 C
สภาวะแวดล้อมที่อนุญาต	
- อุณหภูมิขาร์จ	0... +45 °C
- อุณหภูมิใช้งาน ²⁾	-10... +45 °C
- อุณหภูมิเก็บรักษา	-20... +70 °C
- ความชื้นสัมพัทธ์ (ไม่ควบแน่น)	20... 80 %
แบตเตอรี่ที่แนะนำ	GBA 10,8 V GBA 12 V
เครื่องชาร์จที่แนะนำ	AL 11.. CV GAL 12.. CV

เครื่องมือวัดนี้มีหมายเลขเครื่อง 2 บนแผ่นป้ายรุ่น

1) ที่อุณหภูมิล้อมรอบ 20–23 °C และค่าสัมประสิทธิ์การแผ่รังสีความร้อน >0.999 ระยะห่างการวัด: 0.3 m เวลาทำงาน: >5 นาที

2) ผลการทำงานน้อยลงที่อุณหภูมิต่ำ <0 °C

กำหนดข้อมูลทางเทคนิคด้วยแบตเตอรี่ที่จัดส่งมา

การประกอบ

แหล่งจ่ายไฟฟ้า

เครื่องมือวัดสามารถทำงานกับแบตเตอรี่มาตรฐาน (ประเภทแบตเตอรี่ AA/LR6 หรือเทียบเท่า) หรือแบตเตอรี่ ลิเทียม-ไอออน ของ บ็อช

การทำงานกับแบตเตอรี่อะแดปเตอร์ (ถอดออกได้) (ดูภาพประกอบ A)

ต้องใส่แบตเตอรี่เข้าไปในแบตเตอรี่อะแดปเตอร์

▶ **แบตเตอรี่อะแดปเตอร์ที่มีไว้สำหรับใช้ในเครื่องมือวัด บ็อช ที่ออกแบบมาให้ใช้ได้เท่านั้น และต้องไม่นำมาใช้ร่วมกับเครื่องมือไฟฟ้า**

เมื่อต้องการใส่แบตเตอรี่ ให้เลื่อนปลอกหุ้มแบตเตอรี่ อะแดปเตอร์ 21 เข้าในช่องแบตเตอรี่ 18 ใส่แบตเตอรี่เข้าไปใน ปลอกหุ้มตามภาพประกอบบนฝาปิด 20 เลื่อนฝาปิดไปบน ปลอกหุ้มจนฝาปิดขมเข้าที่อย่างรู้สึกได้และราบเสมอกับ ด้านจับของเครื่องมือวัด



เมื่อต้องการถอดแบตเตอรี่ ให้กดปุ่มปลดล็อก 19 ของฝาปิด 20 และดึงฝาปิดออก ระวังระวังอย่า ให้แบตเตอรี่ร่วงหล่นออกมา ถือเครื่องมือวัดโดย ทันช่องแบตเตอรี่ 18 ขึ้นด้านบน ถอดแบตเตอรี่ ออก เมื่อต้องการถอดปลอกหุ้มที่อยู่ด้านใน 21

ออกจากช่องแบตเตอรี่ 18 ให้จับเข้าไปในช่องเว้าของปลอกหุ้ม 22 และดึงปลอกหุ้มออกจากเครื่องมือวัดโดยกดบนผนัง ด้านข้างเล็กน้อย (ดูภาพประกอบ B)

หมายเหตุ: อย่าใช้เครื่องมือ (ต.ย. เช่น ไขควง) เพื่อถอด แบตเตอรี่ออก เพราะปลอกหุ้มอาจแตกหักได้

เปลี่ยนแบตเตอรี่ทุกก่อนพร้อมกันเสมอ โดยใช้แบตเตอรี่ยี่ห้อ เดียวกันทั้งหมดและมีความจุเท่ากันทุกก้อน

▶ **เมื่อไม่ใช้งานเป็นเวลานานให้นำแบตเตอรี่ออกจาก เครื่องมือวัด** หากใส่แบตเตอรี่ทิ้งไว้นานๆ แบตเตอรี่จะเกิดการกัดกร่อนและปล่อยประจุไฟฟ้าออกมา

การทำงานกับแบตเตอรี่แพ็ค (ดูภาพประกอบ C)

หมายเหตุ: การใช้แบตเตอรี่แพ็คที่ไม่เหมาะสมสำหรับเครื่องมือวัด อาจทำให้เกิดการทำงานที่ผิดปกติหรือก่อความเสียหายต่อ เครื่องมือวัดได้

หมายเหตุ: แบตเตอรี่แพ็คที่จัดส่งได้รับการชาร์จไฟไว้บ้าง แล้ว เพื่อให้แบตเตอรี่แพ็คที่ทำงานได้เต็มประสิทธิภาพ ต้อง ชาร์จแบตเตอรี่แพ็คในเครื่องชาร์จแบตเตอรี่ให้เต็มก่อน ใช้งานครั้งแรก

▶ **ใช้เฉพาะเครื่องชาร์จแบตเตอรี่ที่ระบุไว้ใน ข้อมูลทาง เทคนิค เท่านั้น** เฉพาะเครื่องชาร์จแบตเตอรี่เหล่านี้เท่านั้น ที่ถูกออกแบบมาให้ใช้ได้กับแบตเตอรี่แพ็คลิเทียม ไอออน ที่ใช้ในเครื่องมือวัดของท่าน

แบตเตอรี่แพ็คลิเทียม ไอออน สามารถชาร์จได้ตลอดเวลาโดย อายุการใช้งานจะไม่ลดลง การชาร์จจังหวะกระบวนชาร์จ ไม่ทำให้แบตเตอรี่แพ็คเสียหาย

▶ **เมื่อเครื่องมือวัดปิดสวิตช์ลงโดยอัตโนมัติ อยากรอดูปุ่ม เปิด-ปิด อีกต่อไป** แบตเตอรี่อาจชาร์จได้

เมื่อต้องการใส่แบตเตอรี่แพ็คที่ชาร์จแล้ว 23 ให้เลื่อน แบตเตอรี่แพ็คเข้าไปในช่องแบตเตอรี่ 18 จนขมเข้าที่ อยากรู้สึกได้และราบเสมอกับด้านจับของเครื่องมือวัด เมื่อต้องการถอดแบตเตอรี่แพ็ค 23 ให้กดปุ่มปลดล็อก 19 และดึงแบตเตอรี่แพ็คออกจากช่องแบตเตอรี่ 18 อยากรู้ กำลังดึง

ตัวบ่งชี้สถานะแบตเตอรี่

สัญลักษณ์สถานะแบตเตอรี่ f บนจอแสดงผลจะแสดงระดับ การชาร์จของแบตเตอรี่ และ/หรือแบตเตอรี่แพ็ค 23

เครื่องหมายแสดง	ความจุ
	> 2/3
	≤ 2/3
	≤ 1/3
	≤ 10 %
	เปลี่ยนแบตเตอรี่ และ/ หรือแบตเตอรี่แพ็ค

48 | ภาษาไทย

การปฏิบัติงาน

- ▶ **ป้องกันไม่ให้เครื่องมือวัดได้รับความชื้นและโดนแสงแดดส่องโดยตรง**
- ▶ **อย่าให้เครื่องมือวัดได้รับอุณหภูมิที่สูงมาก หรือรับอุณหภูมิที่เปลี่ยนแปลงมาก** ตัวอย่าง เช่น อย่านำปลอกเครื่องมือไว้ในรถยนต์เป็นเวลานาน ในกรณีที่อุณหภูมิมีการเปลี่ยนแปลงมาก ต้องนำปลอกให้เครื่องมือวัดปรับเข้ากับอุณหภูมิรอบด้านก่อนใช้เครื่องทำงาน ในกรณีที่รับอุณหภูมิที่สูงมากหรือรับอุณหภูมิที่เปลี่ยนแปลงมาก เครื่องมือวัดอาจมีความแม่นยำน้อยลง
- ▶ **เอาใจใส่ให้เครื่องมือวัดปรับตัวเข้ากับสภาพอากาศอย่างถูกต้อง** ความผันผวนอุณหภูมิอย่างรุนแรงหรือการเปลี่ยนแปลงสภาพแวดล้อมอย่างรวดเร็ว อาจส่งผลกระทบต่อความแม่นยำการวัดของเครื่องมือวัด ต้องรอจนกว่าเครื่องจะปรับตัวเข้ากับสภาพอากาศได้อย่างเต็มที่อีกครั้ง
- ▶ **อย่าให้เครื่องมือวัดถูกกระแทกอย่างรุนแรงหรืออย่าให้ตกหล่น** หลังได้รับการกระทบจากภายนอกอย่างรุนแรง และเมื่อพบความผิดปกติในการทำงาน ท่านควรส่งเครื่องมือวัดไปตรวจสอบที่ศูนย์บริการลูกค้า บอช ที่ได้รับแต่งตั้ง

การเริ่มต้นใช้งาน**การเปิดและปิดเครื่อง**

เมื่อต้องการวัด ให้เปิดฝาครอบป้องกัน **1** ขึ้นตรวจสอบให้แน่ใจว่าขณะทำงานบริเวณวัด-อินฟราเรด ไม่ถูกปิดหรือบดบังไว้

เมื่อต้องการเปิดสวิตช์เครื่องมือวัด ให้กดปุ่มเปิด-ปิด 9 บนจอแสดงผล 14 ปรากฏลำดับการบดหลังลำดับการบด เครื่องมือวัดจะเริ่มทำการวัดทันที และจะทำงานไปอย่างต่อเนื่องจนกว่าจะปิดสวิตช์

หมายเหตุ: ในนาที่แรกๆ อาจเป็นไปได้ว่าเครื่องมือวัดมักจะปรับตุลตัวเองบ่อยๆ ทั้งนี้เพราะอุณหภูมิเช่นเซอร์และอุณหภูมิล้อมรอบยังไม่ได้ปรับตัวการสอบเทียบใหม่อีกครั้งช่วยให้วัดได้อย่างแม่นยำในระหว่างการสอบเทียบ สภาพความร้อนจะหยุดค้างเป็นเวลานานๆ

เมื่อต้องการปิดสวิตช์เครื่องมือวัด ให้กดปุ่มเปิด-ปิดอีกครั้ง เครื่องมือวัดบันทึกการตั้งค่าทั้งหมด จากนั้นจึงปิดสวิตช์ เครื่องมือวัดฝาครอบป้องกัน **1** เพื่อจะได้ขนย้ายเครื่องมือวัดได้อย่างปลอดภัย

ในเมนูการตั้งค่าท่านสามารถเลือกว่าเครื่องมือวัดจะปิดสวิตช์โดยอัตโนมัติหรือไม่และควรปิดสวิตช์หลังจากช่วงเวลาใด (ดู "เวลาปิดสวิตช์" หน้า 50)

หากแบตเตอรี่แพ็ค และ/หรือเครื่องมือวัด อยู่นอกอุณหภูมิทำงานที่ระบุไว้ในข้อมูลทางเทคนิค เครื่องมือวัดจะปิดสวิตช์หลังการเตือนสั้นๆ (ดู "ความผิดพลาด – สาเหตุและมาตรการแก้ไข" หน้า 52) โดยอัตโนมัติ ปลอกให้เครื่องมือวัดปรับตัวให้ชินกับอากาศ จากนั้นจึงเปิดสวิตช์อีกครั้ง

การเตรียมการวัด**การตั้งค่าสัมประสิทธิ์การแผ่รังสีสำหรับการวัดอุณหภูมิพื้นผิว**

ค่าสัมประสิทธิ์การแผ่รังสีของวัตถุขึ้นอยู่กับวัสดุและลักษณะพื้นผิวของวัสดุ ค่านี้บ่งชี้ว่าวัตถุ (เมื่อเทียบกับวัตถุอื่นๆ ที่มีอุณหภูมิเดียวกัน) แผ่รังสีความร้อนอินฟราเรดมากหรือน้อย สำหรับการกำหนดอุณหภูมิพื้นผิว เราจะวัดการแผ่รังสีความร้อนอินฟราเรดตามธรรมชาติที่ปล่อยออกมาจากวัตถุเป้าหมาย ซึ่งเป็นการวัดแบบไม่สัมผัส เพื่อให้ได้การวัดที่ถูกต้อง ต้องตรวจสอบค่าสัมประสิทธิ์การแผ่รังสีความร้อนที่ติดตั้งไว้ที่เครื่องมือวัด **ในการวัดทุกครั้ง** และปรับให้เข้ากับวัตถุที่วัด หากจำเป็น

ท่านสามารถเลือกค่าสัมประสิทธิ์การแผ่รังสีความร้อนที่ติดตั้งล่วงหน้าค่าใดค่าหนึ่ง หรือป้อนค่าตัวเลขที่แน่นอนตั้งค่าสัมประสิทธิ์การแผ่รังสีความร้อนที่ต้องการในเมนู "การวัด" > "ค่าสัมประสิทธิ์การแผ่รังสี" (ดู หน้า 50)

- ▶ **ท่านสามารถวัดอุณหภูมิได้อย่างถูกต้องหากค่าสัมประสิทธิ์การแผ่รังสีความร้อนที่ติดตั้งไว้และค่าสัมประสิทธิ์การแผ่รังสีความร้อนของวัตถุสอดคล้องกัน**

ความแตกต่างของสีอาจจะเป็นเพราะอุณหภูมิที่แตกต่างกัน และ/หรือค่าสัมประสิทธิ์การแผ่รังสีความร้อนที่แตกต่างกันหากค่าสัมประสิทธิ์การแผ่รังสีความร้อนแตกต่างกันมาก ความแตกต่างของอุณหภูมิที่แสดงอาจคลาดเคลื่อนจากความเป็นจริงอย่างมีนัยสำคัญ

หากมีวัตถุที่วัดหลายชิ้นที่ทำการวัดที่แตกต่างกันหรือมีโครงสร้างที่แตกต่างกันในบริเวณวัด ค่าอุณหภูมิที่แสดงจะผูกพันเฉพาะกับวัตถุที่เหมาะสมกับค่าสัมประสิทธิ์การแผ่รังสีความร้อนที่ติดตั้งไว้เท่านั้นสำหรับวัตถุอื่นๆ ทั้งหมด (ที่มีค่าสัมประสิทธิ์การแผ่รังสีความร้อนอื่นๆ) ความแตกต่างของสีที่แสดงสามารถนำมาใช้เป็นตัวบ่งชี้ความสัมพันธ์ของอุณหภูมิได้

วัสดุ	ค่าสัมประสิทธิ์การแผ่รังสีความร้อน (ค่าอ้างอิง 0 °C ... 100 °C)
คอนกรีต	0.93
ปูนปลาสเตอร์/ปูนมอร์ตาร์	0.93
อิฐ	0.93
กระดาษบุหลังคา	0.93
สีเครื่องทำความร้อน	0.93
ไม้	0.91
กระเบื้องยาง (Linoleum)	0.88
กระดาษ	0.89

ข้อสังเกตเกี่ยวกับเงื่อนไขการวัด

พื้นผิวที่สะท้อนแสงได้ดีหรือเป็นมันเงามาก (ต.ย. เช่น กระจกหรือโลหะที่เป็นมันวาว) สามารถบิดเบือน หรือส่งผลกระทบต่อผลที่แสดงหากจำเป็น ให้ใช้เทปสีดำแบบด้านที่นำความร้อนได้ดีไปปิดทับพื้นผิวการวัด ปลอกให้อุณหภูมิเทปมีค่าเท่ากับพื้นผิววัตถุหลัก

เมื่อพื้นผิวมีการสะท้อนแสง ให้หามุมวัดที่ดี เพื่อที่ว่าการแผ่กระจายความร้อนจากวัตถุอื่น ๆ จะไม่บีบอัดเป็นผลจากการวัด ตัวอย่าง เช่น เมื่อวัดตามแนวตั้งจากด้านหน้า การสะท้อนของความร้อนในร่างกายของท่านเองอาจมีผลต่อการวัดในกรณีของพื้นผิวเรียบ อาจแสดงรูปทรงและอุณหภูมิของร่างกายของท่าน (ค่าสะท้อน) ซึ่งไม่สอดคล้องกับอุณหภูมิแท้จริงของพื้นผิวที่วัด (ค่าที่ปล่อยออกมาหรือค่าแท้จริงของพื้นผิว) ตามหลักการแล้ว เป็นไปไม่ได้ที่จะวัดผ่านวัสดุโปร่งใส (ต.ย. เช่น แก้ว หรือพลาสติกโปร่งใส)

ยังมีเงื่อนไขการวัดที่ดีกว่าและเสถียรกว่า ยิ่งได้ผลจากการวัดถูกต้องมากขึ้นและน่าเชื่อถือยิ่งขึ้น

การวัดอุณหภูมิแบบอินฟราเรดจะได้รับผลกระทบจากควัน ไอหมอก/ความชื้นสูง หรืออากาศที่เต็มไปด้วยฝุ่น

คำแนะนำสำหรับการวัดที่แม่นยำยิ่งขึ้น:

- เข้าใกล้วัตถุที่จะวัดให้มากที่สุดเท่าที่จะเป็นไปได้เพื่อลดปัจจัยรบกวนระหว่างตัวท่านและพื้นผิววัด
- ระบายอากาศพื้นที่ภายในก่อนทำการวัด โดยเฉพาะอย่างยิ่งเมื่ออากาศสกปรกหรือเต็มไปด้วยไอ หลังจากระบายอากาศแล้ว ปล่อยให้ห้องปรับตัวให้ชินกับอากาศสักพัก รอจนกว่าห้องจะมีอุณหภูมิปกติอีกครั้ง

การจัดหมวดหมู่อุณหภูมิด้วยสเกล

ที่ด้านขวาของจอแสดงผลท่านจะเห็นสเกลค่าที่ด้านบนและด้านล่างสุดขึ้นอยู่กับอุณหภูมิสูงสุดหรือต่ำสุดที่ตรวจพบในภาพความร้อน การจัดสรรสีให้กับค่าอุณหภูมิในภาพจะกระจายเท่าๆ กัน (เชิงเส้น)

อุณหภูมิจะถูกจัดหมวดหมู่ภายในค่าขอบเขตทั้งสองนี้ได้ด้วยเฉดสีต่างๆ กัน ตัวอย่าง เช่น อุณหภูมิที่อยู่ระหว่างค่าสูงสุดและต่ำสุดพอดี อาจถูกจัดหมวดหมู่ให้อยู่ในช่วงสีตรงกลางของสเกล

เมื่อต้องการวัดอุณหภูมิของบริเวณเฉพาะเจาะจง ให้เคลื่อนเครื่องมือวัดโดยเล็งจากภาพพร้อมไฟแสดงอุณหภูมิ 1 ไปยังจุดหรือบริเวณที่ต้องการในการตั้งค่าอัตโนมัติ แถบสีของสเกลจะถูกกระจายไปทั่วบนบริเวณวัดทั้งหมดภายในอุณหภูมิสูงสุดและต่ำสุดเป็นเชิงเส้น (เท่าๆ กัน)

กล้องถ่ายภาพความร้อนแสดงอุณหภูมิที่วัดทั้งหมดที่สัมพันธ์ซึ่งกันและกันในบริเวณวัด หากในบริเวณหนึ่ง ตัวอย่าง เช่น ในการแสดงสี ความร้อนในชุดสีปรากฏเป็นสีฟ้า นั่นหมายความว่าบริเวณสีฟ้าเป็นค่าการวัดที่เย็นกว่าในบริเวณวัดปัจจุบันอย่างไรก็ตามบริเวณเหล่านี้อาจอยู่ในช่วงอุณหภูมิที่อาจทำให้เกิดการบาดเจ็บภายใต้สถานการณ์บางอย่างดังนั้นให้ใส่ใจกับอุณหภูมิที่แสดงบนสเกลหรือที่กำกับมาโดยตรงเสมอ

ฟังก์ชัน

การปรับการแสดงผล

ขึ้นอยู่กับสถานการณ์การวัด ชุดสีที่แตกต่างกันจะช่วยให้สามารถวิเคราะห์ภาพความร้อนได้ง่ายยิ่งขึ้น และแสดงวัตถุหรือข้อเท็จจริงบนจอแสดงผลได้ชัดเจนยิ่งขึ้นอุณหภูมิที่วัดจะไม่ได้รับผลกระทบจากการปรับชุดสีเฉพาะ การแสดงออกของค่าอุณหภูมิเท่านั้นที่เปลี่ยนไป

เมื่อต้องการเปลี่ยนชุดสี ให้กดอยู่ในโหมดการวัดและกดปุ่มลูกศรขึ้นไปทางขวา 8 หรือซ้าย 12



การซ้อนภาพความร้อนกับภาพจริง

เพื่อให้เห็นแนวทางดียิ่งขึ้น (= การจัดหมวดหมู่เชิงพื้นที่ของภาพความร้อนที่แสดง) ท่านสามารถเชื่อมต่อภาพจริงที่ตาเห็นที่ช่วงอุณหภูมิที่สมดุลได้ด้วย

หมายเหตุ: การซ้อนภาพความร้อนกับภาพจริงคือที่ระยะห่าง 0.55 ม. ตรง หากระยะห่างไปยังวัตถุที่จะวัดแตกต่างกัน อาจทำให้ภาพความร้อนกับภาพจริงไม่ตรงกัน

กล้องถ่ายภาพความร้อนนี้มีตัวเลือกต่อไปนี้:

- **ภาพอินฟราเรด 100 %**
แสดงเฉพาะภาพความร้อนเท่านั้น
 - **ภาพความร้อนซ้อนบนภาพจริง**
ภาพความร้อนที่แสดงจะถูกตัดและบริเวณโดยรอบจะแสดงเป็นภาพจริง การตั้งค่านี้นี้ช่วยให้จัดหมวดหมู่เฉพาะที่ของบริเวณวัดได้ดียิ่งขึ้น
 - **ความโปร่งแสง**
ภาพความร้อนที่แสดงจะวางซ้อนแบบโปร่งแสงเล็กน้อย บนภาพจริงดังนั้นจึงสามารถมองเห็นวัตถุได้ดีขึ้น
- ท่านสามารถปรับตั้งค่าได้โดยการกดปุ่มลูกศรขึ้นข้างบน 5 หรือลงข้างล่าง 10

การยึดสเกลอยู่กับที่

การกระจายของสีในภาพความร้อนถูกปรับโดยอัตโนมัติ แต่สามารถหยุดได้โดยกดปุ่มฟังก์ชันทางขวา 7 ในลักษณะนี้ ท่านจะสามารถเปรียบเทียบภาพความร้อนที่บันทึกไว้ภายใต้สภาวะอุณหภูมิที่แตกต่างกัน (ต.ย. เช่น เมื่อตรวจสอบห้องหลายห้องเพื่อหาสภาพความร้อน)

หากต้องการเปลี่ยนสเกลให้กลับมาเป็นแบบอัตโนมัติ ให้กดปุ่มฟังก์ชันทางขวา 7 อีกครั้งตอนนี้อุณหภูมิจะทำงานอย่างคล่องแคล่วอีกครั้ง และปรับตัวเข้ากับค่าสูงสุดและต่ำสุดที่วัดได้

ฟังก์ชันการวัด

เมื่อต้องการเข้าถึงฟังก์ชันอื่นๆ ที่สามารถช่วยท่านในการแสดงผล ให้กดปุ่ม "Func" 6 ในตัวเลือกที่ปรากฏให้ท่านทางไปทางขวา/ซ้ายเพื่อเลือกฟังก์ชันเลือกหนึ่งฟังก์ชันและกดปุ่ม "Func" 6 อีกครั้ง

เครื่องนี้มีฟังก์ชันการวัดต่อไปนี้:

- **"อัตโนมัติ"**
การกระจายของสีในภาพความร้อนเป็นไปโดยอัตโนมัติ
- **"ตัวหาร้อน"**
ในฟังก์ชันการวัดนี้จะแสดงเฉพาะอุณหภูมิที่ร้อนขึ้นในบริเวณวัดเป็นภาพความร้อน บริเวณที่อยู่นอกอุณหภูมิที่ร้อนขึ้นนี้จะถูกแสดงเป็นภาพจริงในระดับสีเทา ทั้งนี้เพื่อไม่ให้วัตถุที่มีสีไปรวมอยู่ในอุณหภูมิเนื่องจากเข้าใจผิด (ตัวอย่าง เช่น สายเคเบิลสีแดงในตู้ควบคุมเมื่อค้นหาส่วนประกอบที่ร้อนมากเกินไป) ปรับสเกลด้วยปุ่มขึ้นข้างบน 5 และลงข้างล่าง 10 ช่วงอุณหภูมิที่แสดงจะขยายกว้างขึ้นหรือลดลง
เครื่องจะวัดอุณหภูมิสูงสุดและต่ำสุดต่อไปและแสดงผลที่ปลายสเกลอย่างไรก็ตามท่านสามารถควบคุมได้ว่าช่วงอุณหภูมิใดควรแสดงเป็นภาพความร้อน
- **"ตัวหาเย็น"**
ในฟังก์ชันการวัดนี้จะแสดงเฉพาะอุณหภูมิที่เย็นขึ้นในบริเวณวัดเป็นภาพความร้อน บริเวณที่อยู่นอกอุณหภูมิที่เย็นขึ้นนี้จะถูกแสดงเป็นภาพจริงในระดับสีเทา ทั้งนี้

50 | ภาษาไทย

เพื่อไม่ให้วัตถุที่มีสีไปรวมอยู่ในอุณหภูมิเนื่องจากเข้าใจผิด (ตัวอย่าง เช่น กรอบหน้าต่างสีฟ้าเมื่อค้นหารถยนต์ที่ไม่มีลูกต้อ) ปรับสเกลด้วยปุ่มขึ้นข้างบน 5 และลงข้างล่าง 10 ช่วงอุณหภูมิที่แสดงจะขยายกว้างขึ้นหรือลดลง

เครื่องจะวัดอุณหภูมิสูงสุดและต่ำสุดต่อไปและแสดงผลที่ปลายสเกลอย่างไรก็ตามท่านสามารถควบคุมได้ว่าช่วงอุณหภูมิใดควรแสดงเป็นภาพความร้อนสี

- "ด้วยมือ"

หากวัตถุอุณหภูมิที่แตกต่างกันมากในภาพความร้อน (ต.ย. เช่น เครื่องทำความร้อนเป็นวัตถุร้อนเมื่อตรวจหาสะพานความร้อน) สีที่มีอยู่จะกระจายไปทั่วบนค่าอุณหภูมิจำนวนมากในช่วงระหว่างอุณหภูมิสูงสุดและต่ำสุดนี้อาจนำไปสู่ข้อเท็จจริงที่ว่าเครื่องไม่สามารถแสดงความแตกต่างของอุณหภูมิที่เล็กน้อยมากได้อย่างละเอียดอีกต่อไปเมื่อต้องการได้รายละเอียดของอุณหภูมิที่โฟกัสมากขึ้น ให้ทำตามขั้นตอนต่อไปนี้: หลังจากเปลี่ยนไปเป็นโหมด "ด้วยมือ" แล้ว ท่านจะสามารถตั้งค่าอุณหภูมิสูงสุดและต่ำสุด นี้จะช่วยให้ท่านสามารถกำหนดช่วงอุณหภูมิที่เกี่ยวข้องกับท่าน และช่วงอุณหภูมิที่ท่านต้องการเห็นความแตกต่างที่เล็กน้อยมากการตั้งค่า รีเซต จะปรับสเกลให้เหมาะสมกับค่าที่วัดในเขตมุมมองของเซนเซอร์อินฟราเรดโดยอัตโนมัติ

เมนูหลัก

เมื่อต้องการไปที่เมนูหลัก ให้กดปุ่ม "Func" 6 เพื่อเรียกดูฟังก์ชันการวัด จากนั้นกดปุ่มฟังก์ชันทางขวา 7

- "การวัด"

- "คำลัพท์การแฟร้งสี" c:

สำหรับวัสดุที่ใช้บ่อยที่สุดบางประเภท เครื่องมีคำลัพท์การแฟร้งสีที่บันทึกไว้แล้วให้เลือก ให้เลือกวัสดุที่เหมาะสมในเมนูไอเท็ม "วัสดุ" คำลัพท์การแฟร้งสีที่สอดคล้องกันจะแสดงในบรรทัดด้านล่าง

หากท่านทราบคำลัพท์การแฟร้งสีที่แน่นอนของวัตถุที่วัด ท่านสามารถปรับตั้งค่านี้เป็นค่าตัวเลขในเมนูไอเท็ม "คำลัพท์การแฟร้งสี"

- "อุณหภูมิสะท้อน":

การตั้งค่าของพารามิเตอร์นี้จะช่วยปรับปรุงผลการวัด โดยเฉพาะอย่างยิ่งในวัสดุที่มีคำลัพท์การแฟร้งสีต่ำ (การสะท้อนสูง) โดยปกติ อุณหภูมิสะท้อนมักจะตรงกับอุณหภูมิล้อมรอบ

หากวัตถุที่มีอุณหภูมิเบี่ยงเบนมากอยู่ใกล้กับวัตถุที่สะท้อนแสงมาก และสามารถส่งผลกระทบต่อการวัด คำนี้ควรถูกปรับเปลี่ยน

- "การแสดงผล"

- "จุดร้อน" k: "เปิด-ปิด"

ในฟังก์ชันนี้จุดที่ร้อนที่สุด (= พิกเซลการวัด) ในบริเวณวัดจะถูกทำเครื่องหมายโดยอัตโนมัติด้วยกากบาทสีแดงในภาพความร้อนในลักษณะนี้ท่านจะสามารถมองเห็นจุดวิกฤตได้ง่ายขึ้น ต.ย. เช่น แคลมป์ยึดที่หลุดหลวมในตู้ควบคุม

- "จุดเย็น" m: "เปิด-ปิด"

จุดที่เย็นที่สุด (= พิกเซลการวัด) ในบริเวณวัดจะถูกทำเครื่องหมายโดยอัตโนมัติด้วยกากบาทสีฟ้าในภาพความร้อนในลักษณะนี้ท่านจะสามารถมองเห็นจุดวิกฤตได้ง่ายขึ้น ต.ย. เช่น จุดรั่วไหลในฉนวน

- "กากบาท" l: "เปิด-ปิด"

กากบาทจะปรากฏตรงกลางในภาพความร้อนและแสดงค่าอุณหภูมิที่วัดได้ ณ จุดนี้

- "สเกล" h: "เปิด-ปิด"

- "WiFi": "เปิด-ปิด"

(ดู "การถ่ายทอดข้อมูล" หน้า 51)

- "Track My Tools": "เปิด-ปิด"

(ดู "TrackMyTools" หน้า 52)

- "เครื่อง"

- "ภาษา"

ภายใต้เมนูไอเท็มนี้ท่านสามารถปรับเปลี่ยนภาษาของตัวแสดงผลทั้งหมด

- "เวลา & วันที่" a

เมื่อต้องการเปลี่ยนวันที่และเวลาในตัวแสดงผล ท่านต้องเรียกเมนูย่อย "เวลา & วันที่" ในเมนูย่อยนี้ ท่านสามารถเปลี่ยนรูปแบบของวันที่และเวลาได้ด้วย เมื่อต้องการออกจากเมนูย่อย "เวลา & วันที่" ให้กดปุ่มฟังก์ชันทางซ้าย 13 ได้ไอคอนเช็คถูกเพื่อบันทึกการตั้งค่า หรือปุ่มฟังก์ชันทางขวา 7 ได้ไอคอนเช็คคิดเพื่อยกเลิกการเปลี่ยนแปลง

- "สัญญาณเสียง": "เปิด-ปิด"

ภายใต้เมนูไอเท็มนี้ท่านสามารถเปิด-ปิดเสียงสัญญาณ

- "เวลาปิดสวิตช์"

ภายใต้เมนูไอเท็มนี้ท่านสามารถเลือกช่วงเวลาที่จะเครื่องมือวัดจะปิดสวิตช์โดยอัตโนมัติเมื่อไม่มีการกดปุ่มใดๆท่านสามารถยับยั้งการปิดสวิตช์โดยอัตโนมัติโดยเลือกการตั้งค่า "ไม่" ได้ด้วย

- "ลบภาพทั้งหมด"

ภายใต้เมนูไอเท็มนี้ท่านสามารถลบเพิ่มทั้งหมดที่เก็บไว้ในหน่วยความจำภายในทั้งหมดที่เดียวกดปุ่มลูกศรชี้ไปทางขวา 8 สำหรับ เพิ่มเติม ... เพื่อเข้าสู่เมนูย่อย จากนั้นกดปุ่มฟังก์ชันทางซ้าย 13 ได้ไอคอนเช็คถูกเพื่อยกเลิกทั้งหมด หรือปุ่มฟังก์ชันทางขวา 7 ได้ไอคอนเช็คคิดเพื่อยกเลิกการดำเนินการ

- "ข้อมูลเครื่อง"

ภายใต้เมนูไอเท็มนี้ท่านสามารถเรียกดูข้อมูลเกี่ยวกับเครื่องมือวัดตรงนี้ท่านจะพบหมายเลขเครื่องมือวัดและรุ่นซอฟต์แวร์ที่ติดตั้ง

หากต้องการออกจากเมนูใดๆ และกลับสู่หน้าจอการแสดงผลแบบมาตรฐาน ท่านยังสามารถกดปุ่ม 17 ได้อีกด้วย

กระบวนการเก็บข้อมูลของผลการวัด

การบันทึกผลการวัด

ทันทีหลังจากเปิดสวิตช์ เครื่องมือวัดจะเริ่มต้นทำการวัดและทำการอย่างต่อเนื่องจนกว่าจะปิดสวิตช์

เมื่อต้องการบันทึกภาพ ให้เล็งกล้องไปยังวัตถุที่ต้องการวัด และกดปุ่มบันทึก 11 ภาพจะถูกเก็บไว้ในหน่วยความจำภายในของกล้องอีกทางเลือกหนึ่งคือกดปุ่มหยุดการวัด 17 กาวัดถูกหยุดไว้และแสดงผลบนจอแสดงผลในลักษณะนี้จะช่วยให้ท่านสามารถดูภาพได้อย่างไม่รีบร้อนหากท่านไม่ต้องการบันทึกภาพที่หยุดไว้ ให้กลับไปโหมดการวัดอีกครั้งโดยกดปุ่ม 17 หากท่านต้องการจัดเก็บภาพในหน่วยความจำภายในของกล้อง ให้กดปุ่มบันทึก 11

การเรียกดูภาพที่บันทึกไว้

เมื่อต้องการเรียกดูภาพความร่อนที่บันทึกไว้ให้ดำเนินการดังนี้:

- กดปุ่มฟังก์ชันทางซ้าย **13** ตอนนี้จะปรากฏภาพที่บันทึกไว้ล่าสุดในจอแสดงผล
- ในการสลับระหว่างภาพความร่อนที่เก็บไว้ ให้กดปุ่มลูกศรซ้ายไปทางขวา **8** หรือทางซ้าย **12**

การลบภาพที่บันทึกไว้

เมื่อต้องการลบภาพความร่อนแต่ละภาพ ให้ไปในเมนูต่อไปนี้:

- กดปุ่มฟังก์ชันทางขวา **7** ได้ไอคอนถังขยะ
- ยืนยันการดำเนินการด้วยปุ่มฟังก์ชันทางซ้าย **13** หรือยกเลิกการลบโดยกดปุ่มฟังก์ชันทางขวา **7** ได้ไอคอนการยกเลิก

ลบภาพทั้งหมด

ในเมนู **"ลบภาพทั้งหมด"** ท่านสามารถลบแฟ้มที่เก็บไว้ในหน่วยความจำภายในออกในครั้งเดียว

กดปุ่ม **"Func"** **6** เพื่อเรียกดูฟังก์ชันการวัดตอนนี้ให้กดปุ่มฟังก์ชันทางขวา **7** และเลือก **"เครื่อง"** > **"ลบภาพทั้งหมด"** กดปุ่มลูกศรซ้ายไปทางขวา **8** เพื่อเข้าสู่เมนูย่อย จากนั้นกดปุ่มฟังก์ชันทางซ้าย **13** ได้ไอคอนเช็คถูกเพื่อลบไฟล์ทั้งหมดหรือปุ่มฟังก์ชันทางขวา **7** ได้ไอคอนเช็คผิดเพื่อยกเลิกการดำเนินการ

การถ่ายทอดข้อมูล**การถ่ายทอดข้อมูลผ่าน USB-อินเทอร์เน็ตเฟส**

เปิดฝาครอบพอร์ตไมโคร USB 3 ใช้สายเคเบิลไมโคร USB ที่จัดส่งมาเชื่อมต่อพอร์ตไมโคร USB ของเครื่องมือวัดเข้ากับคอมพิวเตอร์ส่วนบุคคลหรือคอมพิวเตอร์เคลื่อนที่ของท่าน

ตอนนี้ให้เปิดสวิตช์กล้องถ่ายภาพความร่อนด้วยปุ่ม **9**

เปิดไฟล์เบราว์เซอร์ และเลือกไดรฟ์ **"BOSCH GTC 400 C"**

ท่านสามารถคัดลอกไฟล์ JPG ที่บันทึกไว้จากหน่วยความจำภายในของเครื่องมือวัด ย้ายไปยังคอมพิวเตอร์ของท่าน หรือลบออก

เมื่อสิ้นสุดการดำเนินงานที่ต้องการ ให้ถอดการเชื่อมต่อไดรฟ์ตามมาตรฐาน และปิดสวิตช์กล้องถ่ายภาพความร่อน **9** อีกครั้ง

ถอดสายเคเบิลไมโคร USB ระหว่างขั้นตอนการวัดและปิดฝาครอบ **3**

ข้อควรระวัง: ให้ล็อกเอาท์ไดรฟ์จากระบบปฏิบัติการของท่านก่อนทุกครั้ง (eject ไดรฟ์) มิฉะนั้นหน่วยความจำภายในของกล้องถ่ายภาพความร่อนอาจเสียหายได้

ปิดฝาครอบ USB-อินเทอร์เน็ตเฟสเสมอ ฝุ่นละอองหรือน้ำที่สาตกระเด็นจะไม่สามารถหลุดเข้าไปในครอบเครื่องได้

หมายเหตุ: เชื่อมต่อเครื่องมือวัดเข้ากับคอมพิวเตอร์ส่วนบุคคลหรือโน้ตบุ๊กเท่านั้นเครื่องอาจเสียหายได้ถ้าท่านเชื่อมต่อเข้ากับอุปกรณ์อื่น

หมายเหตุ: ใช้ไมโคร USB-อินเทอร์เน็ตเฟสเฉพาะสำหรับการถ่ายทอดข้อมูลเท่านั้น – ไม่สามารถใช้ชาร์จแบตเตอรี่และแบตเตอรี่แพ็คได้

กระบวนการหลังการถ่ายภาพความร่อน

ท่านสามารถแก้ไขภาพความร่อนที่บันทึกไว้โดยใช้ระบบปฏิบัติการ Windows บนคอมพิวเตอร์ของท่านเมื่อต้องการแก้ไขภาพ ให้ดาวน์โหลด GTC-Transfer-Software จากหน้าผลิตภัณฑ์ของกล้องถ่ายภาพความร่อนที่

www.bosch-professional.com/gtc

การถ่ายทอดข้อมูลผ่าน WiFi

เครื่องมือวัดนี้มีโมดูล WiFi ซึ่งช่วยให้สามารถส่งภาพที่เก็บไว้จากกล้องถ่ายภาพความร่อนของท่านไปยังอุปกรณ์เคลื่อนที่ที่ปลายทางแบบไร้สายได้

สำหรับการถ่ายทอดนี้จำเป็นต้องใช้แอปพลิเคชัน (App)

"Measuring Master" เป็นอินเทอร์เน็ตเฟสซอฟต์แวร์ ท่านสามารถดาวน์โหลดแอปพลิเคชันเหล่านี้ตามประเภทอุปกรณ์ปลายทางได้จากแหล่งรวมแอปพลิเคชันที่เกี่ยวข้อง:



นอกเหนือไปจากการถ่ายทอดข้อมูลของรูปภาพของท่านแบบไร้สายแล้ว แอปพลิเคชัน **"Measuring Master"** ยังช่วยให้ท่านสามารถขยายขอบเขตการทำงานเพิ่มขึ้น และลดความยุ่งยากของกระบวนการที่เกิดขึ้นทีหลัง รวมทั้งช่วยส่งต่อข้อมูลที่วัด (ต.ย. เช่น ทางอีเมล) ข้อมูลเกี่ยวกับความต้องการของระบบที่จำเป็นสำหรับการเชื่อมต่อแบบไร้สาย กรุณาดูในเว็บไซต์ของ บ็ช

www.bosch-professional.com/gtc

เมื่อต้องการเปิด-ปิดการเชื่อมต่อ WiFi ให้ไปที่เมนูหลักนำทางด้วยปุ่มเพื่อเลือก **"WiFi"** และเปิด-ปิดการใช้งานไฟแสดง **e** ปรากฏบนจอแสดงผล ตรวจสอบให้แน่ใจว่าอินเทอร์เน็ตเฟส-ไร้สาย บนอุปกรณ์เคลื่อนที่ปลายทางของท่านเปิดใช้งานอยู่

หลังจากแอปพลิเคชันของ บ็ช เริ่มทำงาน (เมื่อโมดูลไร้สายทำงานอยู่) การเชื่อมต่อระหว่างอุปกรณ์เคลื่อนที่ปลายทางและเครื่องมือวัดจะเกิดขึ้น ปฏิบัติตามคำแนะนำการใช้ **"Measuring Master"**

52 | ภาษาไทย

ความผิดพลาด – สาเหตุและมาตรการแก้ไข

ในกรณีที่มีข้อผิดพลาดเกิดขึ้น เครื่องจะรีบูตและสามารถนำมาใช้อีกครั้งในภายหลังไม่เช่นนั้นเมื่อมีข้อความแสดงความคิดเห็นอย่างถาวร การอธิบายโดยสรุปด้านล่างนี้จะช่วยท่านได้

ความผิดพลาด	สาเหตุ	มาตรการแก้ไข
เครื่องมือวัดเปิดสวิตช์ไม่ได้	แบตเตอรี่แฟค และ/หรือแบตเตอรี่หมด	ชาร์จแบตเตอรี่แฟค และ/หรือเปลี่ยนแบตเตอรี่
	แบตเตอรี่แฟคร้อนเกินไป และ/หรือเย็นเกินไป	ปล่อยให้แบตเตอรี่แฟคปรับตัวให้ชินกับอากาศ และ/หรือเปลี่ยนแบตเตอรี่แฟค
	เครื่องมือวัดร้อนเกินไป และ/หรือเย็นเกินไป	ปล่อยให้เครื่องมือวัดปรับตัวให้ชินกับอากาศ
	หน่วยความจำเก็บรูปภาพบกพร่อง	ฟอร์แมตหน่วยความจำภายในโดยลบรูปภาพทั้งหมดออก (ดู "ลบภาพทั้งหมด" หน้า 51) หากยังคงมีปัญหาอยู่ ให้ส่งเครื่องมือวัดไปยังศูนย์บริการลูกค้า บ็อกซ์ ที่ได้รับมอบหมาย
	หน่วยความจำรูปภาพเต็ม	โอนย้ายรูปภาพไปยังสื่อบันทึกข้อมูลอื่น (เช่น คอมพิวเตอร์ หรือ ไนต์บู๊ก) หากจำเป็นจากนั้นให้ลบรูปภาพในหน่วยความจำภายในออก
	เครื่องมือวัดบกพร่อง	ส่งเครื่องมือวัดไปยังศูนย์บริการลูกค้า บ็อกซ์ ที่ได้รับมอบหมาย
เครื่องมือวัดไม่สามารถเชื่อมต่อกับคอมพิวเตอร์	คอมพิวเตอร์ไม่รู้จักเครื่องมือวัด	ตรวจสอบว่าไดรเวอร์ในคอมพิวเตอร์ของท่านเป็นปัจจุบันหรือไม่ หากจำเป็น อาจต้องติดตั้งระบบปฏิบัติการรุ่นใหม่กว่าบนคอมพิวเตอร์
	พอร์ตไมโคร USB หรือสายไมโคร USB บกพร่อง	ตรวจสอบว่าเครื่องมือวัดสามารถเชื่อมต่อกับคอมพิวเตอร์เครื่องอื่นได้หรือไม่ หากไม่ได้ ให้ส่งเครื่องมือวัดไปยังศูนย์บริการลูกค้า บ็อกซ์ ที่ได้รับมอบหมาย

คำนิยาม

การแผ่รังสีความร้อนอินฟราเรด

การแผ่รังสีความร้อนอินฟราเรด คือ การแผ่พลังงานแม่เหล็กไฟฟ้าที่ปล่อยออกมาจากพื้นผิวของวัตถุปริมาณของรังสีขึ้นอยู่กับอุณหภูมิและค่าสัมประสิทธิ์การแผ่รังสีของวัตถุ

ค่าสัมประสิทธิ์การแผ่รังสี

ค่าสัมประสิทธิ์การแผ่รังสีของวัตถุขึ้นอยู่กับวัสดุและลักษณะพื้นผิวของวัสดุค่าสัมประสิทธิ์การแผ่รังสีของวัตถุใดๆ คือ อัตราส่วนระหว่างรังสีความร้อนอินฟราเรดที่แผ่ออกมาจากวัตถุนั้นๆ ต่อพลังงานที่แผ่ออกมาจากตัวแผ่ความร้อนในอุดมคติ (วัตถุดำ, ค่าสัมประสิทธิ์การแผ่รังสี $\epsilon = 1$)

สะพานความร้อน

สะพานความร้อน คือ วัตถุที่นำความร้อนออกไปข้างนอกหรือเข้ามาด้านในซึ่งไม่ต้องการให้เห็นเช่นนั้น และดังนั้นอุณหภูมิของวัตถุจึงแตกต่างจากอุณหภูมิของผนังห้องที่ต้องการและ/หรือที่เหลือนอก

เนื่องจากอุณหภูมิพื้นผิวที่สะพานความร้อนต่ำกว่าอุณหภูมิส่วนที่เหลือในห้อง ตรงจุดนี้จึงมีความเสี่ยงจากการก่อตัวของเชื้อรามากขึ้นอย่างมีนัยสำคัญ

อุณหภูมิสะท้อน/การสะท้อนกลับของวัตถุ

อุณหภูมิสะท้อนคือการแผ่รังสีความร้อนที่ไม่ได้ออกมาจากวัตถุเองรังสีจากสิ่งแวดล้อมจะสะท้อนในวัตถุที่วัดทั้งนี้ขึ้นอยู่กับโครงสร้างและวัสดุ และดังนั้นจึงบีบอัดเป็นผลของอุณหภูมิที่แท้จริง

ระยะวัดดู

ระยะห่างระหว่างวัตถุที่วัดและเครื่องมือวัดที่ผลิตต่อขนาดพื้นที่ที่ตรวจจับต่อพิทเซลเมื่อระยะห่างวัตถุเพิ่มขึ้น ท่านสามารถจับภาพวัตถุขนาดใหญ่ขึ้น

ระยะห่าง (ม.)	ขนาดพิทเซลอินฟราเรด (มม.)	ขอบเขตอินฟราเรด กว้าง x สูง (ม.)
0.5	3	~0.5 x 0.4
1	6	~1 x 0.75
2	12	2.05 x 1.5
5	30	5.1 x 3.8

TrackMyTools

Bluetooth® Low Energy Module แบบเบ็ดเสร็จช่วยทำให้เป็นส่วนบุคคลและตรวจสอบสถานะของเครื่องมือวัด ตลอดจนถ่ายโอนการตั้งค่าและข้อมูลโดยใช้เทคโนโลยีไร้สาย Bluetooth®

แหล่งจ่ายไฟฟ้า TrackMyTools-Bluetooth®-โมดูล

เครื่องมือวัดนี้มีถ่านกระดุม ดังนั้นแม้ไม่มีแบตเตอรี่แฟค 23 หรือแบตเตอรี่ใส่อยู่ อุปกรณ์เคลื่อนที่ปลายทางยังสามารถค้นพบเครื่องมือวัดผ่าน TrackMyTools ได้

ค้นหาข้อมูลเพิ่มเติมได้โดยตรงใน App ของ บ็อกซ์

การถ่ายทอดข้อมูล

ท่านสามารถเปิดหรือปิดสวิตช์ TrackMyTools-Bluetooth®-โมดูลในการตั้งค่าอุปกรณ์ หลังจากนั้นโมดูลจะส่งสัญญาณอย่างต่อเนื่อง

ระยะทางการส่งสัญญาณของโมดูลคือแปดวินาที อาจจำเป็น ต้องมีระยะทางการส่งสัญญาณถึงสามารถรอบก่อนจะตรวจพบ เครื่องมือวัด ทั้งนี้ขึ้นอยู่กับสภาพแวดล้อม

หมายเหตุ: ปิดสวิตช์ TrackMyTools เมื่อท่านอยู่ในพื้นที่ที่ห้ามส่งคลื่นวิทยุ ด.ย. เช่น ในเครื่องบิน

การลงทะเบียนและการตั้งค่า App/เว็บแอปพลิเคชัน

เพื่อที่จะสามารถจะใช้ TrackMyTools ท่านต้องลงทะเบียนออนไลน์ก่อน

เปิดเว็บไซต์ www.bosch-trackmytools.com และลงทะเบียน หลังเสร็จสิ้นการลงทะเบียน ท่านจะได้รับข้อมูลล็อกอินของท่าน

ให้ความมีโหลด App TrackMyTools ผ่าน App Store ที่สอดคล้องกัน (Apple App Store, Google Play Store)

หรือเรียกใช้งานเว็บแอปพลิเคชันผ่าน <https://web.bosch-trackmytools.com>

ที่นี่ท่านสามารถเข้าสู่ระบบโดยป้อนข้อมูลล็อกอินของท่าน จากนั้นท่านสามารถสร้างและจัดการรายการสั่งซื้อของของท่าน โดยใช้ App/เว็บแอปพลิเคชัน

หมายเหตุ: ก่อนอื่น ให้ศึกษาโปรแกรมการสอนของ App/เว็บแอปพลิเคชัน ทั้งหมด การศึกษาโปรแกรมการสอนช่วยให้ท่านได้ภาพรวมที่ดีขึ้นเกี่ยวกับขั้นตอนในการสร้างรายการสั่งซื้อ และเกี่ยวกับวิธีการใช้งานซอฟต์แวร์

การบำรุงรักษาและการบริการ**การบำรุงรักษาและการทำความสะอาด**

จัดเก็บและขนย้ายเครื่องมือวัดโดยบรรจุในภาชนะที่เหมาะสม เช่น หีบห่อเดิม หรือกระเป๋าป้องกัน (อุปกรณ์ประกอบ) อย่าติดสติ๊กเกอร์ใกล้เซนเซอร์อินฟราเรดบนเครื่องมือวัด

รักษาเครื่องมือวัดให้สะอาดตลอดเวลา

ขณะทำความสะอาด อย่าให้ของเหลวซึมเข้าไปในเครื่องมือวัด

อย่าพยายามขจัดสิ่งสกปรกออกจากเซนเซอร์ กล้อง หรือเลนส์รับ โดยใช้วัตถุมีคม และอย่าเช็ดกล้องและเลนส์รับ (เสี่ยงต่อการเกิดรอยขีดข่วน)

หากท่านต้องการสอบเทียบเครื่องมือวัดของท่านอีกครั้ง กรุณาติดต่อศูนย์บริการ บ็อช (ดูที่อยู่ในบท "การบริการหลังการขายและคำแนะนำการใช้งาน")

ในกรณีซ่อมแซม ให้ส่งเครื่องมือวัดโดยใส่ในหีบห่อเดิม หรือกระเป๋าป้องกัน (อุปกรณ์ประกอบ)

ต้องให้ผู้เชี่ยวชาญถอดถ่านกระดุมที่อยู่ภายในเพื่อนำไปกำจัด ท่านั้นการเปิดฝาครอบอาจทำให้เครื่องมือวัดเสียหายได้ ชนสกรูที่ครอบเครื่องมือวัด และถอดครอบเครื่องมือวัด ถ่านกระดุมออกมา

การบริการหลังการขายและคำแนะนำการใช้งาน

ศูนย์บริการหลังการขายของเรายินดีตอบคำถามเกี่ยวกับการบำรุงรักษาและการซ่อมแซมผลิตภัณฑ์ของท่าน รวมทั้งชิ้นส่วนอะไหล่ ภาพแยกชิ้นประกอบและข้อมูลเกี่ยวกับชิ้นส่วนอะไหล่ยังสามารถดูได้ที่:

www.bosch-pt.com

ทีมงานให้คำแนะนำการใช้งานของ บ็อช ยินดีตอบคำถามเกี่ยวกับผลิตภัณฑ์ของเราและอุปกรณ์ประกอบของผลิตภัณฑ์ เมื่อต้องการสอบถามและสั่งซื้ออะไหล่ กรุณาแจ้งหมายเลขสินค้า 10 หลักบนแผ่นป้ายรุ่นของผลิตภัณฑ์ทุกครั้ง

ไทย

บริษัท โรเบิร์ต บ็อช จำกัด
ชั้น 11 ตึกลิเบอร์ตี สแควร์

287 ถนนสีลม บางรัก
กรุงเทพฯ 10500

โทรศัพท์ 02 6393111

โทรสาร 02 2384783

บริษัท โรเบิร์ต บ็อช จำกัด ตู้ ปณ. 2054

กรุงเทพฯ 10501 ประเทศไทย

www.bosch.co.th

ศูนย์บริการซ่อมและฝึกอบรม บ็อช

อาคาร ลาซาลทาวเวอร์ ชั้น G ห้องเลขที่ 2

บ้านเลขที่ 10/11 หมู่ 16

ถนนศรีนครินทร์

ตำบลบางแก้ว อำเภอบางพลี

จังหวัดสมุทรปราการ 10540

ประเทศไทย

โทรศัพท์ 02 7587555

โทรสาร 02 7587525

การขนส่ง

แบตเตอรี่แพ็คลิเธียม ไอออน ที่ใช้งานได้ อยู่ภายใต้ข้อ

กำหนดแห่งกฎหมายสินค้าอันตราย ผู้ใช้สามารถขนส่ง

แบตเตอรี่แพ็คโดยทางถนนโดยไม่มีข้อบังคับอื่น

หากขนส่งโดยบุคคลที่สาม (ด.ย. เช่น การขนส่งทางอากาศ

หรือตัวแทนขนส่งสินค้า) ต้องปฏิบัติตามข้อกำหนดพิเศษ

เกี่ยวกับการบรรจุภัณฑ์และการติดฉลาก ในการจัดเตรียม

สิ่งของที่จะจัดส่ง ต้องปรึกษามุขนีเขี้ยวสำหรับวัตถุอันตราย

ส่งแบตเตอรี่แพ็คเมื่อตัวหุ้มไม่ชำรุดเสียหายเท่านั้น ใช้

แถบกาวยันปิดหน้าสัมผัสที่เปิดอยู่ และนำแบตเตอรี่แพ็คใส่

กล่องบรรจุโดยไม่ให้เคลื่อนไปมาในกล่องได้

นอกจากนี้กรุณาปฏิบัติตามกฎระเบียบของประเทศซึ่งอาจมี

รายละเอียดเพิ่มเติม

การกำจัดขยะ

เครื่องมือวัด แบตเตอรี่แพ็ค/แบตเตอรี่ อุปกรณ์ประกอบ และหีบห่อ ต้องนำไปแยกประเภทวัสดุเพื่อนำกลับมาใช้ใหม่โดยไม่ทำลายสภาพแวดล้อม



อย่าทิ้งเครื่องมือวัด และแบตเตอรี่/แบตเตอรี่ชาร์จใหม่ได้ ลงในถังขยะบ้าน!

แบตเตอรี่แพ็ค/แบตเตอรี่:**Li-ion:**

กรุณาปฏิบัติตามคำสั่งในบท "การขนส่ง" หน้า 53

ขอสงวนสิทธิ์ในการเปลี่ยนแปลงโดยไม่ต้องแจ้งล่วงหน้า

Bahasa Indonesia

Petunjuk-Petunjuk untuk Keselamatan Kerja



Semua petunjuk harus dibaca dan diperhatikan. Jika alat ukur tidak digunakan sesuai petunjuk yang tersedia, sistem perlindungan pada alat ukur dapat terganggu. SIMPAN PETUNJUK INI DENGAN BAIK.

- ▶ **Biarkan alat pengukur direparasi hanya oleh para teknisi ahli dan hanya dengan menggunakan suku cadang yang asli.** Dengan demikian, keselamatan kerja dengan alat pengukur ini selalu terjamin.
- ▶ **Janganlah menggunakan alat pengukur di ruangan yang terancam bahaya terjadinya ledakan, di mana ada cairan, gas atau debu yang mudah terbakar.** Di dalam alat pengukur bisa terjadi bunga api, yang lalu menyulut debu atau uap.
- ▶ **Lepaskan aki atau baterai sebelum bekerja menggunakan alat ukur (misalnya instalasi, perawatan, dll) serta saat pengangkutan dan penyimpanan.**
- ▶ **Janganlah membuka baterai isi ulang.** Ada bahaya terjadinya korsleting.



Lindungi baterai isi ulang terhadap panas, misalnya juga terhadap penyinaran matahari untuk waktu yang lama, api, air dan kebasahan. Ada bahaya terjadinya ledakan.



- ▶ **Jika baterai isi ulang tidak digunakan, jauhkan baterai isi ulang dari klip untuk kertas, uang logam, kunci, paku, sekrup atau benda-benda kecil dari logam lainnya, yang dapat menjembatani kontak-kontak.** Korsleting antara kontak-kontak baterai isi ulang dapat mengakibatkan kebakaran atau api.
- ▶ **Jika baterai isi ulang tidak digunakan dengan benar, dapat keluar cairan dari baterai isi ulang.** Jagalah supaya Anda tidak terkena cairan ini. Jika secara tidak disengaja Anda terkena cairan ini, cucikan dengan air. Jika cairan tersebut terkena pada mata, selain tindakan di atas, segera hubungi seorang dokter. Cairan yang keluar dari baterai isi ulang dapat mengakibatkan gangguan pada kulit atau kebakaran.
- ▶ **Jika baterai isi ulang rusak atau digunakan secara salah, baterai isi ulang dapat mengeluarkan uap.** Biarkan udara segar mengalir masuk dan jika Anda merasa tidak enak badan, pergilah ke dokter. Uap tersebut dapat mengganggu saluran pernafasan.
- ▶ **Isikan baterai isi ulang hanya dalam alat pencas baterai yang dianjurkan oleh produsennya.** Alat pencas baterai yang khusus untuk mengisi baterai isi ulang tertentu dapat mengakibatkan kebakaran jika digunakan untuk mengisi baterai isi ulang yang tidak cocok.
- ▶ **Gunakanlah baterai isi ulang hanya dengan alat pengukur bermerek Bosch.** Hanya dengan demikian baterai isi ulang dilindungi terhadap pembebanan yang terlalu berat yang membahayakan.
- ▶ **Baterai dapat rusak disebabkan benda-benda lancip seperti jarum, obeng atau tekanan keras dari luar.** Hal ini dapat menyebabkan terjadinya hubungan pendek internal dan baterai dapat terbakar, berasap, meledak, atau mengalami panas berlebih.
- ▶ **Adaptor baterai dirancang untuk alat ukur Bosch yang disediakan dan tidak boleh digunakan dengan alat-alat listrik.**
- ▶ **Keluarkanlah baterai-baterai dari alat pengukur, jika alat pengukur tidak digunakan untuk waktu yang lama.** Jika baterai disimpan untuk waktu yang lama, baterai bisa berkorosi dan mengosong sendiri.
- ▶ **Lindungilah alat pengukur, terutama area kamera dan lensa inframerah dari kelembapan dan salju.** Lensa penerima dapat berembun dan mendistorsi hasil pengukuran. Pengaturan perangkat yang salah dan faktor-faktor atmosfer lainnya dapat menyebabkan kesalahan pengukuran. Objek dapat ditampilkan lebih panas atau lebih dingin yang dapat menimbulkan bahaya apabila disentuh.
- ▶ **Perbedaan suhu tinggi dalam citra termal dapat menyebabkan suhu tinggi yang ditunjukkan secara otomatis dengan suatu warna yang disatukan dengan suhu rendah.** Melakukan kontak dengan permukaan tersebut dapat menyebabkan luka bakar!
- ▶ **Pengukuran suhu yang tepat hanya dapat dilakukan apabila emisivitas yang ditetapkan dan emisivitas objek telah sesuai.** Objek dapat ditampilkan dalam suhu dan/atau warna yang lebih panas atau lebih dingin yang dapat menimbulkan bahaya apabila disentuh.
- ▶ **Berhati-hatilah! Ketika menggunakan alat pengukur dengan Bluetooth®, dapat muncul gangguan pada perangkat dan instalasi lain, pesawat terbang, dan perangkat medis (misalnya alat pacu jantung, alat bantu dengar).** Selain itu, cedera pada manusia dan binatang tidak dapat seluruhnya dihindari dalam area yang tidak terhalang. Jangan menggunakan alat pengukur dengan Bluetooth® di dekat perangkat medis, pusat pengisian bahan bakar, instalasi kimia, area dengan bahaya ledakan dan percikan api. Jangan menggunakan alat pengukur dengan Bluetooth® dalam pesawat terbang. Hindari pengoperasian dalam waktu yang lama di dekat kepala secara langsung.
- ▶ **Alat pengukur dilengkapi dengan antarmuka radio.** Batasan pengoperasian setempat, misalnya dalam pesawat terbang atau di rumah sakit, harus diperhatikan.

Penjelasan tentang produk dan daya

Istilah merek *Bluetooth®* beserta logo adalah merek dagang yang terdaftar dan merupakan milik Bluetooth SIG, Inc. Segala penggunaan istilah/logo ini berada di bawah lisensi Robert Bosch Power Tools GmbH.

Penggunaan

Kamera citra termal ini dirancang untuk pengukuran tanpa kontak pada suhu permukaan.

Citra termal yang ditampilkan menunjukkan distribusi suhu area lensa inframerah yang terdeteksi sehingga memungkinkan untuk menunjukkan variasi suhu warna yang berbeda.

Dengan demikian, permukaan dan benda dapat diperiksa tanpa kontak terhadap perbedaan atau ketidaknormalan suhu untuk melihat komponen dan/atau kelemahan, misalnya:

- Insulasi panas dan isolasi (misalnya ditemukannya thermal bridge)
- Pipa air panas dan hangat aktif (misalnya pemanas lantai) di lantai dan dinding
- Komponen listrik yang terlalu panas, seperti sekring atau terminal
- Bagian mesin (misalnya overheat akibat bantalan bola yang rusak)

Alat ini tidak boleh digunakan untuk mengukur suhu manusia juga binatang atau tujuan medis lainnya.

Alat ini tidak cocok untuk mengukur suhu permukaan gas atau cairan.

Bagian-bagian pada gambar

Nomor-nomor dari bagian-bagian alat pengukur pada gambar sesuai dengan gambar alat pengukur pada halaman bergambar.

- 1 Tutup pelindung untuk kamera visual dan sensor inframerah
- 2 Nomor model
- 3 Penutup soket mikro USB
- 4 Soket mikro USB
- 5 Tombol panah atas
- 6 Tombol fungsi pengukuran „Func“
- 7 Perubahan skala suhu otomatis-tetap / tombol fungsi kanan
- 8 Tombol panah kanan
- 9 Tombol untuk menghidupkan dan mematikan
- 10 Tombol panah bawah
- 11 Tombol Simpan
- 12 Tombol panah kiri
- 13 Tombol Galeri/tombol fungsi kiri

- 14 Display
- 15 Kamera visual
- 16 Area sensor inframerah
- 17 Tombol penghentian pengukuran/melanjutkan pengukuran
- 18 Kotak baterai
- 19 Tombol pelepas baterai/adaptor baterai
- 20 Tutup adaptor baterai*
- 21 Kerangka adaptor baterai*
- 22 Ceruk kerangka
- 23 Baterai*
- 24 Kabel mikro USB
- 25 Tas pelindung*

*Aksesori yang ada dalam gambar atau yang dijelaskan tidak termasuk dalam alat pengukur standar yang dipasok.

Simbol pada display

- a Tanggal/waktu
- b Fungsi pengukuran
- c Indikator emisivitas
- d Display sambungan *Bluetooth*[®]
- e Display WiFi on/off
- f Petanda keberisian baterai
- g Tampilan suhu permukaan maksimum dalam area pengukuran
- h Skala
- i Tampilan suhu permukaan minimum dalam area pengukuran
- j Simbol kunci skala
- k Tampilan hotspot (contoh)
- l Tanda bidik dengan tampilan suhu
- m Tampilan coldspot (contoh)
- n Simbol galeri

Data teknis

Kamera citra termal	GTC 400 C
Nomor model	3 601 K83 1..
Pemutusan sensor inframerah	160 x 120
Sensitivitas termal	< 50 mK
Rentang spektral	8 – 14 μ m
Ruang pandang (FOV)	53 x 43°
Jarak fokus	\geq 0,3 m
Fokus	fix
Area pengukuran suhu permukaan	- 10... + 400 °C

Anda bisa mengidentifikasi alat pengukur Anda dengan pasti, dengan nomor seri **2** pada label tipe.

1) Pada suhu sekitar sebesar 20 – 23 °C dan emisivitas > 0,999, jarak pengukuran: 0,3 m, waktu pengoperasian: > 5 menit

2) daya dibatasi pada suhu < 0 °C

Data teknis diukur dengan aki yang ikut dipasok.

56 | Bahasa Indonesia

Kamera citra termal	GTC 400 C
Ketepatan pengukuran (yang biasa)	
Suhu permukaan¹⁾	
-10...+10 °C	±3 °C
10...100 °C	±3 °C
> +100 °C	±3 %
Jenis display	TFT
Ukuran display	3,5"
Resolution display	320 x 240
Format gambar	.jpg
Citra yang disimpan tiap proses penyimpanan	1 x citra termal (tangkapan layar) 1 x citra acuan visual termasuk nilai suhu (metadata)
Jumlah gambar di memori gambar internal (khusus)	500
Kamera visual terintegrasi	●
Baterai (mangan-alkali)	4 x 1,5 V LR6 (AA) (dengan adaptor baterai)
Baterai isi ulang (Li-ion)	10,8 V/12 V
Port USB	1.1
Suplai daya modul TrackMyTools-Bluetooth®	
- Baterai kancing	CR2450 (Baterai lithium 3 V)
- Daya tahan baterai sekitar	60 Bulan
Bluetooth®	Bluetooth® 4.2 (Daya rendah)
Daya transmisi maksimum Bluetooth®	3,2 mW
Pita frekuensi Bluetooth®	2,402 – 2,480 GHz
Konektivitas nirkabel	WiFi
Daya transmisi maksimum WiFi	30 mW
Rentang frekuensi operasi WiFi	2,400 – 2,483 GHz
Berat sesuai dengan EPTA-Procedure 01:2014	0,54 kg
Ukuran (panjang x lebar x tinggi)	233 x 95 x 63 mm
Jenis perlindungan (kecuali kotak baterai)	IP 53
Kondisi sekitar yang diperbolehkan	
- Suhu pengisian daya	0... +45 °C
- Suhu pengoperasian ²⁾	-10... +45 °C
- Suhu penyimpanan	-20... +70 °C
- Kelembapan relatif (non-kondensasi)	20... 80 %
Baterai yang disarankan	GBA 10,8 V GBA 12 V
Pengisi daya baterai yang direkomendasikan	AL 11.. CV GAL 12.. CV

Anda bisa mengidentifikasi alat pengukur Anda dengan pasti, dengan nomor seri **2** pada label tipe.

1) Pada suhu sekitar sebesar 20 – 23 °C dan emisivitas > 0,999, jarak pengukuran: 0,3 m, waktu pengoperasian: > 5 menit

2) daya dibatasi pada suhu < 0 °C

Data teknis diukur dengan aki yang ikut dipasok.

Cara memasang

Suplai daya

Alat pengukur dapat dioperasikan dengan baterai biasa (baterai AA tipe LR6 atau serupa) atau dengan baterai Li-ion Bosch.

Pengoperasian dengan adaptor baterai (dapat dilepas) (lihat gambar A)

Baterai dimasukkan ke dalam adaptor baterai.

► **Adaptor baterai dirancang untuk alat ukur Bosch yang disediakan dan tidak boleh digunakan dengan alat-alat listrik.**

Untuk **memasang** baterai, geser kerangka adaptor baterai **21** di kompartemen baterai **18**. Masukkan baterai seperti ilustrasi yang terdapat pada tutup bersegel **20**. Geser tutup bersegel di atas kerangka, hingga tutup terkait dengan benar dan rata pada alat.



Untuk **melepas** baterai, tekan tombol pelepas **19** tutup bersegel **20** dan lepas tutup bersegelnya. Pada saat melepas, pastikan baterai tidak terjatuh. Pegang alat pengukur dengan mengarahkan kompartemen baterai **18** ke atas. Lepaskan baterai. Untuk melepaskan kerangka yang berada

di dalam **21** dari kompartemen baterai **18**, pegang ceruk pada kerangka **22** dan tarik keluar dengan menekan secara perlahan pada samping alat pengukur (lihat gambar B).

Petunjuk: Jangan gunakan alat (seperti obeng) untuk melepaskan baterai karena dapat merusak kerangka.

Gantikanlah selalu semua baterai sekaligus. Gunakanlah baterai-baterai yang sama merknya dan dengan kapasitas yang sama.

► **Keluarkanlah baterai-baterai dari alat pengukur, jika alat pengukur tidak digunakan untuk waktu yang lama.**

Jika baterai disimpan untuk waktu yang lama, baterai bisa berkorosi dan mengosong sendiri.

Pengoperasian dengan baterai isi ulang (lihat gambar C)

Petunjuk: Penggunaan baterai isi ulang yang tidak cocok bagi alat pengukur Anda dapat mengakibatkan alat pengukur tidak berfungsi dengan baik atau menjadi rusak.

Petunjuk: Baterai isi ulang dipasang dalam keadaan diisi sebagian. Untuk menjamin daya penuh dari baterai isi ulang, sebelum penggunaannya untuk pertama kalinya, isikan baterai isi ulang sampai penuh sama sekali di dalam alat pencas baterai.

► **Hanya gunakan pengisi baterai yang terdaftar di data teknis.** Hanya pengisi baterai ini yang dicocokkan pada baterai ion-Li yang dapat dipakai untuk alat Anda.

Baterai isi ulang Li-ion dapat diisi sewaktu-waktu, tanpa mengurangi daya tahannya. Baterai isi ulang tidak menjadi rusak jika pengisiannya dihentikan untuk sementara waktu.

► **Setelah penonaktifan perkakas ukur secara otomatis, jangan tekan tombol on-off.** Baterai bisa rusak.

Untuk **memasang** baterai yang terisi **23**, geser baterai ini ke dalam kompartemen baterai **18**, hingga tutup terkait dengan benar dan rata pada pegangan.

Untuk **melepas** baterai **23**, tekan tombol pelepas **19** dan tarik baterai keluar dari kompartemen baterai **18**. **Jangan menariknya terlalu kencang.**

Petanda keberisian baterai

Indikator tingkat pengisian **f** pada display menunjukkan tingkat pengisian baterai atau aki **23**.

Petanda	Kapasitas
	> 2/3
	≤ 2/3
	≤ 1/3
	≤ 10 %
	Mengganti baterai atau aki

Penggunaan

- **Lindungilah alat pengukur terhadap cairan dan sinar matahari yang langsung.**
- **Jagalah supaya alat pengukur tidak terkena suhu yang luar biasa atau perubahan suhu yang luar biasa.** Misalnya, janganlah meninggalkan alat pengukur untuk waktu yang lama di dalam mobil. Jika ada perubahan suhu yang besar, biarkan alat pengukur mencapai suhu yang merata dahulu sebelum Anda mulai menggunakannya. Pada suhu yang luar biasa atau jika ada perubahan suhu yang luar biasa, ketelitian pengukuran alat pengukur bisa terganggu.
- **Perhatikan aklimatisasi yang tepat pada alat pengukur.** Dalam keadaan fluktuasi suhu yang tinggi atau kondisi lingkungan yang berubah drastis, ketepatan pengukuran alat pengukur dapat terganggu hingga dapat diaklimatisasi kembali sepenuhnya.
- **Hindari guncangan dan benturan yang keras pada alat ukur.** Sebaiknya kunjungi pusat layanan resmi Bosch setelah alat ukur mendapat dampak yang kuat dari luar dan saat mengalami kelainan fungsi.

Cara penggunaan

Menghidupkan/mematikan

Bukalah tutup pelindung **1** untuk mengukur. **Pastikan area pengukuran inframerah tidak tertutup atau terhalang saat pengukuran berlangsung.**

Untuk **menghidupkan** alat pengukur, tekan tombol on/off **9**. Pada display **14** akan muncul urutan start. Setelah urutan start, alat pengukur segera memulai pengukuran dan melanjutkannya secara terus-menerus sampai dimatikan.

Petunjuk: Di menit pertama, dapat terjadi bahwa alat pengukur menyesuaikan secara otomatis karena suhu sensor dan suhu sekitar belum disesuaikan. Kalibrasi ulang memungkinkan pengukuran yang tepat. Selama kalibrasi, citra termal akan berhenti sesaat.

Untuk **mematikan** alat pengukur, tekan tombol on/off. Alat pengukur menyimpan semua pengaturan dan kemudian mati secara otomatis. Tutuplah tutup pelindung **1** agar menjamin keamanan transportasi alat pengukur.

Dalam menu pengaturan, terdapat pilihan lama waktu penonaktifan otomatis pada alat pengukur (lihat „Waktu penonaktifan“, halaman 60).

Apabila alat pengukur atau baterai berada di luar suhu pengoperasian yang dijelaskan di dalam data teknis, maka alat akan mati secara otomatis setelah muncul peringatan singkat (buka „Storing – sebabnya dan cara membetulkan“, halaman 61). Biarkan alat pengukur menyesuaikan suhu lingkungan lalu nyalakan kembali.

Persiapan mengukur

Mengatur emisivitas pengukuran suhu permukaan

Emisivitas suatu objek bergantung pada material dan struktur permukaannya. Ini menunjukkan apakah suatu objek memancarkan banyak atau sedikit radiasi inframerah (dibandingkan dengan objek lain dengan suhu yang sama).

58 | Bahasa Indonesia

Untuk menentukan suhu permukaan, radiasi panas inframerah alami akan diukur tanpa adanya kontak yang dipancarkan oleh objek tujuan. Untuk pengukuran yang benar, emisivitas yang diatur pada alat pengukur harus diperiksa **pada setiap pengukuran** dan, jika perlu, disesuaikan dengan objek pengukuran.

Anda dapat memilih salah satu emisivitas preset atau memasukkan nilai angka yang tepat. Aturlah emisivitas yang diinginkan pada menu „**Pengukuran**“ > „**Emisivitas**“ (lihat halaman 59).

► **Pengukuran suhu yang tepat hanya dapat dilakukan apabila emisivitas yang ditetapkan dan emisivitas objek telah sesuai.**

Perbedaan warna dapat disebabkan oleh suhu yang berbeda dan/atau perbedaan emisivitas. Pada emisivitas yang sangat berbeda, perbedaan suhu yang ditunjukkan dapat berbeda jelas dari yang sebenarnya.

Jika ada beberapa objek pengukuran dari material yang berbeda atau struktur yang berbeda di area pengukuran, maka nilai suhu yang ditampilkan hanya mengikat pada objek yang sesuai untuk emisivitas yang ditetapkan. Untuk semua objek lain (dengan emisivitas yang berbeda), perbedaan warna yang ditampilkan dapat digunakan sebagai indikasi hubungan suhu.

Bahan	Emisivitas (Nilai acuan 0 °C ... 100 °C)
Beton	0,93
Plester/mortar	0,93
Bata	0,93
Lapisan bitumen atap	0,93
Radiator paint	0,93
Kayu	0,91
Linoleum	0,88
Kertas	0,89

Indikasi kondisi pengukuran

Permukaan yang begitu memantul atau mengilau (misalnya ubin atau logam yang mengkilap) dapat mendistorsi atau memengaruhi hasil yang ditampilkan. Bila perlu, pasang permukaan pengukur dengan lakban hitam lebar sebagai konduktor yang baik. Biarkan sebentar agar pita menyesuaikan suhu di permukaan.

Perhatikan saat permukaan yang memantul pada sudut pengukur, sehingga radiasi panas yang dipantulkan dari objek lainnya tidak mengubah hasil. Misalnya, saat mengukur vertikal dari depan, pantulan panas tubuh Anda sendiri dapat memengaruhi pengukuran. Untuk permukaan datar, garis bentuk dan suhu tubuh Anda dapat ditampilkan (nilai yang dipantulkan) yang tidak sesuai dengan suhu sebenarnya dari permukaan yang diukur (nilai yang dipancarkan atau nilai permukaan sesungguhnya).

Pengukuran dengan menembus melalui material yang transparan (misalnya gelas atau plastik transparan) pada dasarnya tidak dapat dilakukan.

Jika kondisi pengukuran lebih stabil dan lebih baik, hasil pengukuran dapat semakin tepat dan dapat diandalkan.

Pengukuran suhu inframerah dapat terganggu oleh asap, uap/tingkat kelembapan udara atau udara yang berdebu.

Petunjuk untuk akurasi pengukuran yang lebih baik:

- Berdirilah sedekat mungkin dengan objek pengukuran untuk meminimalisir gangguan antara Anda dan permukaan pengukuran.
- Alirkanlah udara di ruangan sebelum mengukur, terutama bila udara kotor atau sangat lembap. Biarkan sejenak ruangan yang telah dialiri udara agar menyesuaikan suhu, sampai ruangan mencapai suhu normal.

Pengelompokkan suhu menggunakan skala

Skala ditampilkan di sisi kanan display. Nilai pada ujung atas dan bawah didasarkan pada suhu maksimum atau minimum yang terdeteksi pada citra termal. Pembagian warna ke nilai suhu pada gambar dilakukan secara merata (linier).

Dengan penggunaan warna yang berbeda, suhu dapat ditetapkan dalam dua nilai batas tersebut. Suhu yang terletak persis antara nilai maksimum dan minimum misalnya dapat digabungkan pada area warna tengah.

Untuk menentukan suhu area yang spesifik, gerakkanlah alat pengukur sehingga garis bidik dengan tampilan suhu I diarahkan ke titik atau area yang diinginkan.

Dalam pengaturan otomatis, spektrum warna skala selalu dibagi ke seluruh area pengukuran dalam suhu maksimum atau minimum secara linier (=merata).

Kamera citra termal menampilkan semua suhu terukur dalam area pengukuran secara sebanding satu sama lain. Jika, di suatu area, misalnya dalam representasi warna, panas pada rentang warna kebiru-biruan, ini berarti bahwa daerah kebiruan ini termasuk dalam nilai pengukur yang lebih dingin di area pengukuran saat ini. Namun, area ini mungkin masih berada dalam rentang suhu yang mungkin dapat menyebabkan cedera. Oleh karena itu, perhatikanlah selalu suhu yang ditunjukkan pada skala atau langsung ke garis bidik.

Fungsi

Menyesuaikan tampilan warna

Bergantung pada situasi pengukuran, rentang warna yang berbeda dapat mempermudah analisis citra termal, dan dapat menampilkan benda atau objek lebih jelas pada display. Suhu yang diukur tidak terpengaruh oleh hal ini. Hanya tampilan nilai warna yang akan berubah.

Untuk mengubah rentang warna, tetapkan berada di mode pengukuran dan tekan tombol panah kanan **8** atau kiri **12**.

Tumpang tindih citra termal dan citra acuan

Untuk orientasi yang lebih baik (= pembagian ruang citra termal yang ditampilkan), citra acuan visual dapat juga diaktifkan pada rentang suhu seimbang.



Petunjuk: Superposisi citra acuan dan citra termal akan tepat pada jarak 0,55 m. Perbedaan jarak terhadap objek pengukuran dapat menyebabkan ketidaksesuaian antara citra acuan dan citra termal.

Kamera citra termal menawarkan pilihan berikut ini:

- **100 % citra inframerah**
Hanya menampilkan citra termal.
- **Gambar dalam gambar**
Citra termal ditampilkan dalam potongan gambar dan area sekitarnya ditampilkan sebagai citra acuan. Pengaturan ini meningkatkan pemetaan lokal area pengukuran.
- **Transparansi**
Citra termal yang ditampilkan diletakkan secara transparan di atas citra acuan. Dengan demikian, objek dapat dikenali dengan lebih baik.

Dengan menekan tombol panah atas **5** atau bawah **10**, Anda dapat menyesuaikan pengaturan.

Menentukan skala

Penyesuaian distribusi warna pada citra termal dilakukan secara otomatis, namun dapat dihentikan dengan menekan tombol fungsi kanan **7**. Hal ini memungkinkan untuk membandingkan citra termal yang direkam dalam kondisi suhu yang berbeda (misalnya ketika memeriksa beberapa ruang terhadap thermal bridge).

Untuk mengaktifkan kembali skala secara otomatis, tekan tombol fungsi kanan **7**. Kini, suhu bergerak secara dinamis kembali dan menyesuaikan nilai minimum dan nilai maksimum yang terukur.

Fungsi pengukuran

Untuk mengakses lebih banyak fungsi yang dapat membantu Anda pada tampilan, tekan tombol **„Func“ 6**. Arahkan ke opsi yang ditampilkan dengan tombol kanan/kiri untuk memilih fungsi. Pilihlah satu fungsi dan tekan tombol **„Func“ 6**.

Terdapat beberapa fungsi pengukuran:

- **„Otomatis“**
Distribusi warna pada citra termal dilakukan secara otomatis.
- **„Pelacak temperatur panas“**
Dalam fungsi pengukuran ini, hanya suhu yang lebih panas yang ditampilkan di area pengukuran sebagai citra termal. Area di luar suhu yang lebih panas ini ditampilkan sebagai citra acuan dalam grayscale agar tidak keliru dalam menghubungkan objek berwarna dengan suhu (misalnya kabel merah di kabinet kontrol pada pencarian komponen yang terlalu panas). Sesuaikanlah skala dengan tombol atas **5** dan bawah **10**. Dengan ini, rentang suhu yang ditampilkan ditambah atau dikurangi. Perangkat tetap mengukur suhu minimum dan maksimum dan menampilkannya pada ujung skala. Namun, Anda dapat mengontrol rentang suhu yang harus ditampilkan sebagai citra termal dalam warna.
- **„Pelacak temperatur dingin“**
Dalam fungsi pengukuran ini, hanya suhu yang lebih dingin yang ditampilkan di area pengukuran sebagai citra termal. Area di luar suhu yang lebih dingin ditampilkan sebagai citra acuan dalam grayscale agar tidak keliru dalam menghubungkan objek berwarna dengan suhu (misalnya bingkai jendela biru pada pencarian isolasi yang rusak). Sesuai-

kanlah skala dengan tombol atas **5** dan bawah **10**. Dengan ini, rentang suhu yang ditampilkan ditambah atau dikurangi. Perangkat tetap mengukur suhu minimum dan maksimum dan menampilkannya pada ujung skala. Namun, Anda dapat mengontrol rentang suhu yang harus ditampilkan sebagai citra termal dalam warna.

- **„Manual“**
Jika suhu yang sangat berbeda diukur dalam citra termal (misalnya radiator sebagai objek panas pada pemeriksaan thermal bridge), warna yang tersedia didistribusikan melalui nilai suhu yang tinggi dalam rentang antara suhu maksimum dan minimum. Hal ini dapat menyebabkan bahwa perbedaan suhu yang baik tidak dapat ditampilkan secara rinci lagi. Untuk menuju tampilan suhu fokus yang detil, lakukan hal berikut: Setelah mengganti mode **„Manual“**, Anda dapat mengatur suhu maksimal atau minimal. Oleh karena itu, Anda dapat menentukan rentang suhu yang tepat untuk Anda dan perbedaan suhu yang ingin dideteksi. Pengaturan **Reset** menyesuaikan kembali skala secara otomatis dengan nilai-nilai yang diukur di area pandang sensor inframerah.

Menu utama

Untuk menuju menu utama, tekan tombol **„Func“ 6** untuk mengakses fungsi pengukuran. Tekan tombol fungsi kanan **7**.

- **„Pengukuran“**
 - **„Emisivitas“ c:**
Emisivitas yang tersimpan akan tersedia sebagai pilihan untuk beberapa material yang sering muncul. Pilihlah material yang sesuai di item menu **„Material“**. Emisivitas terkait akan ditunjukkan pada baris di bawahnya. Apabila Anda mengenali emisivitas persis pada objek pengukuran, Anda dapat menetapkan emisivitas tersebut sebagai nilai di item menu **„Emisivitas“**.
 - **„Temperatur yang direfleksikan“:**
Pengaturan parameter ini meningkatkan hasil pengukuran terutama pada material dengan emisivitas rendah (=pantulan tinggi). Umumnya, suhu yang dipantulkan sesuai dengan suhu sekitar. Jika benda dengan suhu yang sangat menyimpang di sekitar benda yang memantul kuat dapat memengaruhi pengukuran, nilai ini sebaiknya disesuaikan.
- **„Display“**
 - **„Hotspot“ k: „HIDUP/MATI“**
Dalam fungsi ini, titik terpanas (=piksel pengukuran) ditandai secara otomatis dengan garis bidik merah di citra termal dalam area pengukuran. Hal ini dapat memudahkan Anda untuk mengenali titik kritis, misalnya terminal yang longgar di kabinet kontrol.
 - **„Coldspot“ m: „HIDUP/MATI“**
Titik terdingin (= piksel pengukuran) dalam area pengukuran ditandai secara otomatis ditandai dengan garis bidik biru di citra termal. Hal ini dapat memudahkan Anda untuk mengenali titik kritis, misalnya kebocoran dalam isolasi.
 - **„Tanda bidik“ l: „HIDUP/MATI“**
Tanda bidik ditampilkan di tengah pada citra termal dan menampilkan nilai suhu yang terukur pada titik ini.
 - **„Skala“ h: „HIDUP/MATI“**

60 | Bahasa Indonesia

- **„WiFi“: „HIDUP/MATI“**
(lihat „Pengiriman data“, halaman 60)
- **„Track My Tools“: „HIDUP/MATI“**
(lihat „TrackMyTools“, halaman 62)
- **„Perangkat“**
 - **„Bahasa“**
Pada menu ini, Anda dapat mengatur bahasa pada semua tampilan.
 - **„Waktu & tanggal“ a**
Untuk mengubah waktu dan tanggal pada tampilan, akses submenu **„Waktu & tanggal“**. Di submenu ini, Anda dapat mengubah format tanggal dan waktu. Untuk keluar dari submenu **„Waktu & tanggal“**, tekan tombol fungsi kiri **13** di bawah tanda centang untuk menyimpan pengaturan, ataupun tombol fungsi kanan **7** di bawah tanda silang untuk menghapus perubahan.
 - **„Bunyi sinyal“: „HIDUP/MATI“**
Pada menu Sinyal Suara ini, Anda dapat mengaktifkan atau menonaktifkan nada sinyal.
 - **„Waktu penonaktifan“**
Pada menu Waktu ini, Anda dapat memilih interval waktu setelah alat pengukur mati secara otomatis meski tidak ada tombol yang ditekan. Anda juga dapat mematikan penonaktifan otomatis dengan memilih pengaturan **„Tidak pernah“**.
 - **„Hapus semua gambar“**
Pada menu ini, Anda dapat menghapus semua file sekaligus yang tersimpan di memori internal. Tekan tombol panah kanan **8** untuk **„lebih...“** untuk menuju submenu. Kemudian, tekan tombol fungsi kiri **13** di bawah tanda centang untuk menghapus seluruh file, atau tombol fungsi kanan **7** di bawah tanda silang untuk membatalkan proses.
 - **„Informasi perangkat“**
Pada menu ini, Anda dapat mengakses informasi mengenai alat pengukur. Di sana, Anda dapat melihat nomor seri alat pengukur dan Software Version yang terpasang.

Untuk keluar dari menu apapun dan kembali ke layar indikator standar, Anda juga dapat menekan tombol **17**.

Dokumentasi hasil pengukuran

Menyimpan hasil pengukuran

Segera setelah dihidupkan, alat pengukur memulai pengukuran dan melanjutkannya secara terus-menerus sampai dimatikan.

Untuk menyimpan gambar, arahkan kamera ke objek pengukuran yang diinginkan dan tekan tombol Simpan **11**. Gambar disimpan di memori internal kamera. Atau, tekan tombol untuk menghentikan pengukuran **17**. Pengukuran akan dihentikan dan ditampilkan pada display. Hal ini memberikan Anda kesempatan untuk mengamati gambar dengan tenang. Jika Anda tidak ingin menyimpan gambar tersebut, tekan lagi tombol **17** untuk masuk ke mode pengukuran. Jika Anda ingin menyimpan gambar dalam memori internal kamera, tekan tombol Simpan **11**.

Mengakses gambar yang tersimpan

Untuk mengakses citra termal yang disimpan, lakukan hal berikut:

- Tekan tombol fungsi kiri **13**. Pada display akan muncul gambar yang tersimpan terakhir.
- Untuk beralih antara citra termal yang tersimpan, tekan tombol panah kanan **8** atau kiri **12**.

Menghapus gambar yang tersimpan

Untuk menghapus citra termal tunggal, buka tampilan galeri:

- Tekan tombol fungsi kanan **7** di bawah simbol tong sampah.
- Konfirmasi proses dengan tombol fungsi kiri **13** atau batalkan penghapusan dengan menekan tombol fungsi kanan **7** di bawah tanda batal.

Hapus semua gambar

Pada menu **„Hapus semua gambar“**, Anda dapat menghapus sekaligus semua file yang tersimpan di memori internal.

Tekan tombol **„Func“6** untuk mengakses fungsi pengukuran. Tekan tombol fungsi kanan **7** dan pilih **„Perangkat“ > „Hapus semua gambar“**. Tekan tombol panah kanan **8** untuk menuju submenu. Kemudian, tekan tombol fungsi kiri **13** di bawah tanda centang untuk menghapus seluruh file, atau tombol fungsi kanan **7** di bawah tanda silang untuk membatalkan proses.

Pengiriman data

Pengiriman data melalui antarmuka USB

Buka penutup soket micro USB **3**. Sambungkan soket micro USB alat pengukur melalui kabel micro USB yang disertakan dengan PC atau laptop.

Hidupkan kamera citra termal dengan tombol **9**.

Buka file browser dan pilih penggerak **„BOSCH GTC 400 C“**. File JPG yang tersimpan dapat disalin dari memori internal alat pengukur, dipindahkan ke komputer atau dihapus.

Setelah Anda menyelesaikan proses yang diinginkan, lepaskan penggerak dan matikan kamera citra termal dengan tombol **9**.

Lepaskan kabel micro USB selama mengukur dan tutup penutup **3**.

Perhatian: Selalu lakukan log off untuk penggerak dari sistem pengoperasian Anda terlebih dahulu (keluarkan penggerak) sehingga memori internal pada kamera citra termal dapat terhindar dari kerusakan.

Selalu tutup port USB sehingga tidak ada debu atau percikan air yang bisa masuk ke dalam casing.

Petunjuk: Hubungkan alat pengukur hanya dengan PC atau laptop. Perangkat dapat rusak jika dihubungkan dengan perangkat lain.

Petunjuk: Port micro USB hanya berfungsi untuk transfer data – Baterai dan akumulator tidak dapat diisi daya menggunakan port ini.

Mengedit citra termal

Citra termal yang disimpan dapat diedit di komputer dengan sistem operasi Windows. Unduh perangkat lunak transfer GTC dari halaman produk kamera citra termal di www.bosch-professional.com/gtc.

Transfer data melalui WiFi

Alat pengukur dilengkapi dengan modul WiFi yang memungkinkan transmisi gambar yang disimpan secara nirkabel dari kamera citra termal ke perangkat seluler.

Aplikasi (App) „Measuring Master“ diperlukan sebagai antarmuka perangkat lunak. Anda dapat mengunduh aplikasi ini sesuai dengan jenis perangkat yang akan disambungkan pada toko yang sesuai:



Selain mentransfer data gambar secara nirkabel, penggunaan „Measuring Master“ memungkinkan Anda meningkatkan fungsi dan menyederhanakan pengeditan serta transmisi data pengukuran (misalnya melalui email). Informasi mengenai persyaratan sistem yang diperlukan untuk koneksi WiFi dapat ditemukan pada situs internet Bosch di „www.bosch-professional.com/gtc“.

Untuk mengaktifkan/menonaktifkan koneksi WiFi pada alat pengukur, akses menu utama, arahkan dengan tombol untuk memilih „WiFi“ dan aktifkan/nonaktifkan. Pada display akan muncul tampilan **e**. Pastikan antarmuka WiFi pada perangkat seluler telah diaktifkan.

Setelah aplikasi Bosch dimulai, koneksi antara perangkat seluler dan alat pengukur dapat dibuat (dengan modul WiFi yang diaktifkan). Untuk itu, ikuti petunjuk penggunaan „Measuring Master“.

Storing – sebabnya dan cara membetulkan

Jika terjadi gangguan, alat akan memulai ulang dan dapat digunakan kembali. Jika tidak, ikhtisar di bawah akan membantu Anda jika terjadi pesan kesalahan terus-menerus.

Kesalahan	Sebab	Tindakan untuk mengatasi
Perkakas ukur tidak dapat diaktifkan. 	Aki atau baterai kosong	Isilah aki atau ganti baterainya.
	Baterai terlalu panas atau terlalu dingin	Biarkan baterai menyesuaikan suhu lingkungan atau ganti baterai.
	Alat pengukur terlalu panas atau terlalu dingin	Biarkan alat pengukur menyesuaikan suhu.
	Memori gambar rusak	Formatlah memori internal dengan cara menghapus semua gambar (buka „Hapus semua gambar“, halaman 60). Apabila tetap terdapat masalah, kirimlah alat pengukur Anda ke pusat layanan pelanggan Bosch resmi.
	Memori gambar penuh	Pindahkan gambar bila perlu ke media penyimpanan lain (misalnya komputer atau laptop). Hapuslah gambar di memori internal.
	Alat pengukur rusak	Kirim alat pengukur Anda ke pusat layanan pelanggan Bosch resmi.
	Alat pengukur tidak dapat tersambung dengan komputer.	Alat pengukur tidak dikenali oleh komputer. Periksalah apakah penggerak di komputer Anda aktual. Bila perlu, versi sistem pengoperasian yang lebih baru diperlukan di komputer Anda.
	Koneksi mikro USB atau kabel mikro USB rusak	Periksalah apakah alat pengukur dapat tersambung dengan komputer lainnya. Jika tidak, kirim alat pengukur Anda ke pusat layanan pelanggan Bosch resmi.

Penjelasan istilah

Radiasi panas inframerah

Radiasi panas inframerah merupakan pancaran elektromagnetik yang dipancarkan dari tubuh. Besarnya radiasi bergantung pada suhu dan emisivitas tubuh.

Emisivitas

Emisivitas suatu objek bergantung pada material dan struktur permukaannya. Emisivitas menjelaskan, seberapa besar radiasi panas inframerah yang dipancarkan objek dibandingkan dengan pemancar panas ideal (benda hitam, emisivitas $\epsilon = 1$).

62 | Bahasa Indonesia

Jembatan panas

Objek ini disebut sebagai jembatan panas yang menghantarkan panas ke luar atau ke dalam dan oleh karenanya sangat berbeda dari suhu suatu dinding yang diinginkan atau yang tersisa.

Karena suhu permukaan pada jembatan panas lebih rendah dibandingkan di sisa ruangan, maka bahaya jamur akan meningkat secara signifikan di tempat ini.

Suhu yang dipantulkan/pantulan suatu objek

Suhu yang dipantulkan adalah radiasi panas yang tidak berasal dari benda itu sendiri. Bergantung pada struktur dan materialnya, radiasi sekitar akan memantul dalam objek yang akan diukur sehingga mendistorsi hasil suhu yang sebenarnya.

Jarak objek

Jarak antara objek pengukuran dan alat pengukur memengaruhi luas permukaan yang terdeteksi per piksel. Dengan memperbesar jarak objek, Anda dapat menangkap objek yang semakin besar.

Jarak (m)	Ukuran piksel inframerah (mm)	Area inframerah Tinggi x Lebar (m)
0,5	3	~ 0,5 x 0,4
1	6	~ 1 x 0,75
2	12	2,05 x 1,5
5	30	5,1 x 3,8

TrackMyTools

Bluetooth[®] Low Energy Module yang terpasang memungkinkan personalisasi dan pemeriksaan status alat pengukur serta transfer pengaturan dan data berbasis teknologi nirkabel *Bluetooth*[®].

Suplai daya modul TrackMyTools-Bluetooth[®]

Alat pengukur dilengkapi dengan sebuah baterai kancing sehingga juga dapat dideteksi oleh perangkat seluler tanpa menggunakan akumulator **23** atau baterai pada TrackMyTools.

Informasi selengkapnya dapat dilihat langsung di aplikasi Bosch.

Pengiriman data

Modul TrackMyTools-*Bluetooth*[®] dapat diaktifkan atau dinonaktifkan pada pengaturan perangkat. Kemudian, sinyal konstan akan terpancar.

Interval transmisi modul sekitar delapan detik. Di wilayah tertentu, interval transmisi perlu dilakukan hingga tiga kali sebelum alat pengukur terdeteksi.

Petunjuk: Matikan TrackMyTools ketika Anda berada di area yang terdapat adanya larangan transmisi gelombang radio, seperti di dalam pesawat terbang.

Registrasi dan Pengaturan Aplikasi/Aplikasi Web

Untuk menggunakan TrackMyTools, Anda perlu mendaftar secara online terlebih dulu.

Buka situs web www.bosch-trackmytools.com dan daftarkan diri Anda. Setelah selesai melakukan pendaftaran, Anda akan menerima data akses.

Unduh aplikasi **TrackMyTools** melalui App Store (Apple App Store, Google Play Store) atau akses situs web <https://web.bosch-trackmytools.com>. Anda dapat mendaftar menggunakan data akses di situs tersebut.

Kini Anda dapat membuat dan mengelola inventori Anda melalui bantuan aplikasi/aplikasi web.

Petunjuk: Pertama-tama, ikuti tutorial selengkapnya pada aplikasi/aplikasi web. Dengan begitu, Anda akan mendapatkan ikhtisar terbaru mengenai prosedur saat membuat inventaris dan mengenai pengoperasian perangkat lunak.

Rawatan dan servis**Rawatan dan kebersihan**

Letakkan dan pindahkan alat pengukur hanya ke tempat yang sesuai seperti di pembungkus aslinya atau di tas pelindung (aksesori). Jangan pasang stiker di dekat sensor inframerah pada alat pengukur.

Jagalah supaya alat pengukur selalu bersih.

Hati-hati menggunakan zat cair saat membersihkan alat pengukur agar tidak masuk.

Jangan coba membersihkan kotoran dari sensor, kamera atau lensa penerima dengan alat yang tajam, dan jangan mengelap kamera dan lensa penerima (risiko tergores).

Jika Anda ingin melakukan kalibrasi ulang alat pengukur, silakan hubungi pusat layanan Bosch (lihat alamat pada „Layanan pasca beli dan konseling terkait pengoperasian“).

Kirim alat pengukur Anda untuk diperbaiki dalam pembungkus aslinya atau dalam tas pelindung (aksesori). Baterai kancing yang terintegrasi hanya boleh dilepas oleh petugas ahli untuk dibuang. Alat pengukur dapat rusak karena membuka housing. Buka sekrup pada housing dan lepaskan housing untuk mengeluarkan baterai kancing.

Layanan pasca beli dan konseling terkait pengoperasian

Layanan pasca beli Bosch menjawab semua pertanyaan Anda terkait reparasi dan maintenance serta suku cadang produk ini. Gambar tiga dimensi dan informasi terkait suku cadang dapat Anda lihat di:

www.bosch-pt.com

Tim konseling pengoperasian dari Bosch dengan senang hati membantu Anda, jika Anda hendak bertanya tentang produk-produk kami dan aksesorisnya.

Jika Anda hendak menanyakan sesuatu atau memesan suku cadang, sebutkan selalu nomor model yang terdiri dari 10 angka dan tercantum pada label tipe produk.

Indonesia

PT Robert Bosch
Palma Tower 10th Floor
Jl. RA Kartini II-S Kaveling 6 Sek II
Pondok Pinang, Kebayoran Lama
Jakarta Selatan 12310
Tel.: (021) 3005 5800
Fax: (021) 3005 5801
E-Mail: boschpowertools@id.bosch.com
www.bosch-pt.co.id

Transpor

Pada baterai isi ulang Li-ion yang digunakan diterapkan persyaratan terkait peraturan-peraturan tentang bahan-bahan yang berbahaya. Baterai isi ulang dapat diangkut oleh penggunaannya di jalanan tanpa harus memenuhi syarat-syarat tertentu. Pada pengiriman oleh pihak ketiga (misalnya transportasi dengan pesawat udara atau perusahaan ekspedisi) harus ditaati syarat-syarat terkait kemasan dan pemberian tanda. Dalam hal ini, untuk mempersiapkan transportasi harus diminta dukungan seorang ahli bahan-bahan berbahaya. Kirimkan baterai isi ulang hanya jika rumahannya tidak rusak. Kontak-kontak yang terbuka harus ditutupi dengan pita perekat dan kemaskan baterai isi ulang sedemikian, sehingga tidak bergerak-gerak di dalam kemasan. Taatilah peraturan-peraturan nasional lainnya yang mungkin lebih rinci yang berlaku di negara Anda.

Cara membuang



Alat pengukur, aki/baterai, aksesoris dan pembungkus harus disortir untuk daur ulang yang ramah lingkungan.



Janganlah membuang alat pengukur dan baterai isi ulang/baterai ke dalam sampah rumah tangga!

Baterai isi ulang/Baterai:

Ion-Li:

Perhatikanlah petunjuk-petunjuk dalam bab „Transpor“, halaman 63.

Perubahan dapat terjadi tanpa pemberitahuan sebelumnya.

Tiếng Việt

Các Nguyên Tắc An Toàn



Đọc và tuân thủ tất cả các hướng dẫn. Khi sử dụng dụng cụ đo không phù hợp với các hướng dẫn ở trên, các thiết bị bảo vệ được tích hợp trong dụng cụ đo có thể bị suy giảm. **HÃY BẢO QUẢN CÁC HƯỚNG DẪN NÀY MỘT CÁCH CẨN THẬN.**

- ▶ **Chỉ giao dụng cụ đo cho chuyên viên có trình độ chuyên môn và sử dụng phụ tùng chính hãng sửa chữa.** Điều này đảm bảo cho sự an toàn của dụng cụ đo được giữ nguyên.
- ▶ **Không được vận hành dụng cụ đo ở môi trường dễ gây cháy nổ, ví dụ như ở gần nơi có loại chất lỏng dễ cháy, khí gas hay rác.** Các tia lửa có thể hình thành trong dụng cụ đo và có khả năng làm rác cháy hay ngùn khói.
- ▶ **Trước khi tiến hành bất cứ công việc gì với dụng cụ đo (vd., bảo dưỡng, lắp đặt v.v..) cũng như khi vận chuyển hay lưu kho, tháo pin ra khỏi dụng cụ đo.**

- ▶ **Không được mở pin hợp khối ra.** Nguy hiểm do chập mạch.



Bảo vệ pin hợp khối chống lại nhiệt. Ví dụ, chống lại nắng mặt trời gay gắt liên tục chiếu vào, lửa, nước, và sự ẩm ướt.



Nguy hiểm do nổ.

- ▶ **Khi không sử dụng pin hợp khối, để pin tránh xa các vật bằng kim loại khác như kẹp giấy, tiền xu, chìa khóa, đinh, vít hay các đồ vật bằng kim loại khác, thứ có thể tạo ra sự chập nối từ một đầu cực này với một đầu cực khác.** Làm chập mạch các đầu cực với nhau có thể gây bỏng hay cháy.
- ▶ **Trong tình trạng bị đè nén, chất lỏng từ pin hợp khối có thể phun ra; tránh tiếp xúc. Nếu sự vô ý tiếp xúc xảy ra, hãy xối nước để rửa. Nếu chất lỏng tiếp xúc với mắt, cần thêm sự trợ giúp bên y tế.** Chất lỏng phun ra từ pin hợp khối có thể gây ngứa hay bỏng.
- ▶ **Trong trường hợp pin hợp khối bị hư hỏng hay sử dụng sai cách, hơi có thể thoát ra. Đưa thêm không khí trong lành vào và trong trường hợp bị đau, cần tìm sự giúp đỡ của bên y tế.** Hơi bốc ra có thể gây ngứa hệ hô hấp.
- ▶ **Chỉ nạp lại điện bằng bộ nạp điện do nhà sản xuất chỉ định.** Một bộ nạp điện thích hợp cho một loại pin hợp khối có thể tạo ra nguy cơ cháy khi được sử dụng cho một loại pin khác.
- ▶ **Chỉ sử dụng pin hợp khối kết hợp với dụng cụ đo Bosch của bạn.** Chỉ riêng với biện pháp này đã bảo vệ cho pin hợp khối chống lại sự nguy hiểm do quá tải.
- ▶ **Pin có thể bị hư hại bởi các vật dụng nhọn như đinh hay tuốc-nơ-vít hoặc bởi các tác động lực từ bên ngoài.** Nó có thể dẫn tới đoản mạch nội bộ và làm pin bị cháy, bốc khói, phát nổ hoặc quá nóng.
- ▶ **Bộ thích nghi pin hoàn toàn dùng để sử dụng trong các dụng cụ đo của Bosch và không được phép sử dụng cùng với dụng cụ điện tử.**
- ▶ **Tháo pin ra khỏi dụng cụ đo khi không sử dụng trong một thời gian không xác định.** Khi cất lưu kho trong một thời gian không xác định, pin có thể bị ăn mòn và tự phóng hết điện.
- ▶ **Bảo vệ dụng cụ đo, đặc biệt là vùng Camera và ống kính hồng ngoại khỏi độ ẩm và tuyết.** Ống kính thu nhận có thể bị đọng hơi và cho kết quả đo sai. Các điều chỉnh thiết bị sai cũng như các yếu tố ảnh hưởng khác có thể dẫn đến sai. Các vật thể có thể nóng hơn hoặc lạnh hơn, điều này có thể dẫn đến nguy hiểm khi tiếp xúc.
- ▶ **Sự chênh lệch nhiệt độ cao trong ánh nhiệt có thể dẫn tới các nhiệt độ cao được hiển thị bằng các màu, mà làm ta liên tưởng tới nhiệt độ thấp.** Tiếp xúc với bề mặt như thế có thể dẫn đến bỏng!

64 | Tiếng Việt

- ▶ **Chỉ có các phép đo nhiệt độ chính xác, nếu thống nhất được độ phát xạ đã điều chỉnh và độ phát xạ của đối tượng.** Các vật thể có thể nóng hơn hoặc lạnh hơn theo nhiệt độ và/hoặc theo màu, điều này có thể dẫn đến nguy hiểm khi tiếp xúc.
- ▶ **Cẩn thận! Nếu sử dụng máy đo với cổng Bluetooth® có thể gây nhiễu các dụng cụ, thiết bị khác cũng như máy bay và dụng cụ y tế (ví dụ: máy tạo nhịp tim, máy trợ thính). Và cũng không thể loại trừ hoàn toàn những tổn hại cho người và động vật ở môi trường trực diện xung quanh. Không sử dụng máy đo có kết nối Bluetooth® ở gần những thiết bị y tế, trạm xăng, cơ sở hóa học, các khu vực có nguy cơ gây nổ và các khu vực cháy nổ. Không sử dụng máy đo có kết nối Bluetooth® trên máy bay. Tránh để máy hoạt động gần cơ thể trong thời gian dài.**
- ▶ **Máy đo được trang bị một giao diện sóng vô tuyến. Hãy chú ý các giới hạn địa điểm hoạt động ví dụ như trên máy bay hoặc bệnh viện.**

Mô Tả Sản Phẩm và Đặc Tính Kỹ Thuật

Bluetooth® có biểu tượng chữ và biểu tượng ảnh (các logo) do công ty cổ phần Bluetooth SIG đăng ký thương hiệu và sở hữu. Robert Bosch Power Tools GmbH đã được cấp phép để sử dụng những biểu tượng chữ/biểu tượng ảnh này với sản phẩm của mình.

Dành Sử Dụng

Camera ảnh nhiệt được thiết kế để đo nhiệt độ bề mặt mà không cần tiếp xúc chạm.

Ảnh nhiệt đã hiển thị sẽ cho biết sự phân bố nhiệt độ của vùng nhận diện của ống kính hồng ngoại và cho phép hiển thị các chênh lệch nhiệt độ khác nhau theo màu.

Ví dụ, các bề mặt và các vật dụng có thể được kiểm tra về chênh lệch nhiệt hoặc sự bất thường nhiệt độ mà không cần chạm khi sử dụng đúng cách, để hiển thị các chi tiết và/hoặc các chỗ yếu được thấy rõ:

- Lớp cách nhiệt và các lớp cách ly (ví dụ xác định cầu nhiệt)
- Các đường ống nước nóng hoạt động (ví dụ hệ thống sưởi ấm sàn) ở trên sàn và trong tường
- Các chi tiết điện quá nhiệt như cầu chì và thiết bị đầu cuối
- Các chi tiết máy (ví dụ quá nhiệt do ổ bi bị hỏng)

Không được phép dùng dụng cụ đo để đo nhiệt độ con người cũng như động vật hoặc dùng cho các mục đích y tế khác.

Dụng cụ đo không thích hợp để đo nhiệt độ bề mặt chất khí hoặc chất lỏng.

Biểu trưng của sản phẩm

Sự đánh số các biểu trưng của sản phẩm là để tham khảo hình minh họa dụng cụ đo trên trang hình ảnh.

- 1 Nắp đậy bảo vệ của Camera trực quan và cảm biến hồng ngoại
- 2 Số mã dòng
- 3 Vỏ giắc cắm Micro-USB
- 4 Giắc cắm Micro-USB
- 5 Phím nút tên trên
- 6 Nút các chức năng do “Func”
- 7 Thay đổi thang đo nhiệt độ được tự động cố định/Nút chức năng bẹp phải
- 8 Phím mũi tên phải
- 9 Phím Tắt/Mở
- 10 Nút mũi tên xuống
- 11 Lưu nút
- 12 Phím mũi tên trái
- 13 Nút bộ sưu tập/nút chức năng bên trái
- 14 Màn hiển thị
- 15 Camera trực quan
- 16 Vùng cảm biến hồng ngoại
- 17 Nút đóng băng đo/tiếp tục đo
- 18 Cổng bộ nguồn
- 19 Nút mở khóa đầu nối pin/pin
- 20 Đầu chụp của đầu nối pin*
- 21 Vỏ đầu nối pin AA*
- 22 Khe đầu chụp
- 23 Pin*
- 24 Cáp Micro-USB
- 25 Túi xách bảo vệ*

* Các phụ tùng được minh họa hay mô tả không nằm trong tiêu chuẩn hàng hóa được giao kèm.

Hiển thị các Phần tử

- a Ngày/Giờ
- b Chức năng đo
- c Đèn chỉ thị độ phát xạ
- d Hiển thị kết nối *Bluetooth®*
- e Hiển thị WiFi được bật/tắt
- f Đèn hiệu kiểm soát điện áp
- g Hiển thị nhiệt độ bề mặt tối đa trong vùng đo
- h Thước
- i Hiển thị nhiệt độ bề mặt tối thiểu trong vùng đo
- j Biểu tượng khóa thang đo
- k Hiển thị Điểm nóng (làm mẫu)
- l Đường chữ thập với hiển thị nhiệt độ
- m Hiển thị Điểm lạnh (làm mẫu)
- n Biểu tượng Bộ sưu tập

Thông số kỹ thuật

Camera Ảnh nhiệt	GTC 400 C
Mã số máy	3 601 K83 1..
Độ phân giải cảm biến hồng ngoại	160 x 120
Độ nhạy nhiệt	<50 mK
Khoảng phổ	8–14 μm
Trường quan sát (FOV)	53 x 43 °
Khoảng cách tiêu điểm	$\geq 0,3$ m
Tiêu điểm	cố định
Nhiệt độ bề mặt vùng đo	-10...+400 °C
Độ đo chính xác (tiêu biểu)	
Nhiệt độ bề mặt¹⁾	
-10...+10 °C	± 3 °C
10...100 °C	± 3 °C
>+100 °C	± 3 %
Kiểu hiển thị	TFT
Kích thước hiển thị	3,5"
Độ phân giải hiển thị	320 x 240
Định dạng hình ảnh	.jpg
Hình ảnh đã lưu cho mỗi quá trình lưu	1 x ảnh nhiệt (Screenshot) 1 x ảnh thực trực quan gồm các giá trị nhiệt độ (Lý lịch dữ liệu)
Số lượng hình ảnh trong bộ nhớ ảnh bên trong (quy chuẩn)	500
Camera trực quan tích hợp	●
Pin (kiềm-mangan)	4 x 1,5 V LR6 (AA) (với đầu nối pin)
Pin hợp khối (lithium-ion)	10,8 V/12 V
Kết nối USB	1.1
Bộ nguồn TrackMyTools-Mô-đun-Bluetooth®	
- Pin cúc áo	CR2450 (Pin 3-V-Lithium)
- Tuổi thọ pin khoảng	60 Tháng
Bluetooth®	Bluetooth® 4.2 (Năng lượng thấp)
Năng suất truyền tối đa Bluetooth®	3,2 mW
Dải tần số Bluetooth®	2,402–2,480 GHz
Khả năng kết nối không dây	WiFi
Năng suất truyền tối đa WiFi	30 mW
Dải tần số hoạt động WiFi	2,400–2,483 GHz
Trọng lượng theo Qui trình EPTA-Procedure 01:2014 (chuẩn EPTA 01:2014)	0,54 kg
Kích thước (dài x rộng x cao)	233 x 95 x 63 mm
Mức độ bảo vệ (không kể khoang chứa pin)	IP 53
Dụng cụ đo có thể nhận biết rõ ràng bằng chuỗi số dòng 2 trên nhãn ghi loại máy.	
1) với nhiệt độ xung quanh là 20–23 °C và Độ phát xạ là >0,999, khoảng cách đo: 0,3 m, Thời gian vận hành: >5 min	
2) hiệu suất giới hạn ở nhiệt độ <0 °C	
Các dữ kiện kỹ thuật được xác định cho pin được giao cùng hàng hóa cung cấp.	

66 | Tiếng Việt

Camera Ảnh nhiệt

GTC 400 C

Các điều kiện xung quanh cho phép

- Nhiệt độ tải	0...+45 °C
- Nhiệt độ vận hành ²⁾	-10...+45 °C
- Nhiệt độ lưu kho	-20...+70 °C
- Độ ẩm không khí tương đối (không ngưng tụ)	20... 80 %

Pin được khuyến dùng

GBA 10,8 V
GBA 12 V

Thiết bị nạp được giới thiệu

AL 11.. CV
GAL 12.. CV

Dụng cụ đo có thể nhận biết rõ ràng bằng chuỗi số dòng 2 trên nhãn ghi loại máy.

1) với nhiệt độ xung quanh là 20–23 °C và Độ phát xạ là >0,999, khoảng cách đo: 0,3 m, Thời gian vận hành: >5 min

2) hiệu suất giới hạn ở nhiệt độ <0 °C

Các dữ kiện kỹ thuật được xác định cho pin được giao cùng hàng hóa cung cấp.

Sự lắp vào

Nguồn cung năng lượng

Dụng cụ đo có thể được điều khiển bằng pin thông thường (pin AA loại LR6 hoặc tương đương) hoặc với ắc quy Li-Ione của Bosch.

Vận hành bằng bộ thích nghi pin (tháo được) (xem hình A)

Pin phải được lắp vào đầu nối pin.

► Bộ thích nghi pin hoàn toàn dùng để sử dụng trong các dụng cụ đo của Bosch và không được phép sử dụng cùng với dụng cụ điện tử.

Để lắp pin, hãy đẩy vỏ 21 của đầu nối pin vào khe pin 18. Hãy cài pin vào vỏ theo hình minh họa trên đầu chụp 20. Đẩy đầu chụp lên trên vỏ đến khi nó được gài vào khớp và nằm chính xác trên tay cầm của máy đo.



Để tháo pin, hãy nhấn Phím mở khóa 19 đầu chụp 20 và kéo đầu chụp ra. Đảm bảo là pin không bị rơi xuống. Hãy giữ máy đo để khe pin 18 hướng lên trên. Tháo pin ra.

Để tháo vỏ nằm bên trong 21 ra khỏi khe pin 18, nắm chặt vào khe vỏ 22 và kéo nó ra với một lực vừa phải về một phía của máy đo (xem hình B).

Ghi Chú: Không sử dụng dụng cụ để lấy ắc quy (ví dụ Tuốc nơ vít), vì có thể bị gãy.

Luôn luôn thay tất cả pin cùng một lần. Chỉ sử dụng pin cùng một hiệu và có cùng một điện dung.

► Tháo pin ra khỏi dụng cụ đo khi không sử dụng trong một thời gian không xác định. Khi cất lưu kho trong một thời gian không xác định, pin có thể bị ăn mòn và tự phóng hết điện.

Hoạt Động bằng Pin Hợp Khối (xem hình C)

Ghi Chú: Sử dụng các loại pin hợp khối không thích hợp với dụng cụ đo có thể dẫn đến sự trục trặc hay gây hư hỏng cho dụng cụ đo.

Ghi Chú: Pin hợp khối được cung cấp đã được nạp điện một phần. Để bảo đảm pin hoạt động hết công suất, nạp điện toàn bộ pin hợp khối bằng bộ nạp điện trước khi sử dụng dụng cụ đo cho lần đầu tiên.

► **Chỉ sử dụng bộ sạc được để cấp trong dữ liệu kỹ thuật.** Chỉ những thiết bị nạp này phù hợp cho máy đo của bạn có sử dụng pin Li-Ion.

Pin Lithium-Ion hợp khối có thể nạp điện bất cứ lúc nào mà không làm giảm tuổi thọ của pin. Sự gián đoạn trong quá trình nạp điện không làm hư hại pin hợp khối.

► **Không được ấn vào nút bật-tắt sau khi dụng cụ đo tự động tắt.** Pin có thể bị hỏng.

Để lắp pin đã nạp 23, đẩy pin này vào khe pin 18, cho tới khi pin được gài vào khớp và nằm chính xác trên tay cầm của máy đo.

Để tháo pin 23, hãy nhấn Phím mở khóa 19 và kéo pin ra khỏi khe pin 18. **Không dùng sức.**

Bộ Chỉ Báo Tình Trạng Pin

Đèn chỉ thị trạng thái nạp f trên màn hình hiển thị trạng thái nạp của pin hoặc pin 23.

Sự Biểu Thị Điện dung

	> 2/3
	≤ 2/3
	≤ 1/3
	≤ 10 %
	Đổi pin hoặc pin

Vận Hành

- ▶ **Bảo vệ dụng cụ đo tránh khỏi ẩm ướt và không để bức xạ mặt trời chiếu trực tiếp vào.**
- ▶ **Không được để dụng cụ đo ra nơi có nhiệt độ cao hay thấp cực độ hay nhiệt độ thay đổi thái quá.** Như ví dụ sau, không được để dụng cụ đo trong xe ô tô trong một thời gian dài hơn mức bình thường. Trong trường hợp có sự thay đổi nhiệt độ thái quá, hãy để cho dụng cụ đo điều chỉnh theo nhiệt độ chung quanh trước khi đưa vào sử dụng. Trong trường hợp ở trạng thái nhiệt độ cực độ hay nhiệt độ thay đổi thái quá, sự chính xác của dụng cụ đo có thể bị hư hỏng.
- ▶ **Chú ý tuân thủ chính xác các yếu tố thích nghi khí hậu của dụng cụ đo.** Khi có sự dao động nhiệt độ mạnh hoặc các điều kiện môi trường xung quanh thay đổi mạnh thì độ chính xác đo của thiết bị đo có thể bị ảnh hưởng cho đến khi được thích nghi trở lại.
- ▶ **Tránh va chạm mạnh hoặc làm rơi dụng cụ đo.** Sau khi chịu những tác động bên ngoài nặng nề và có các bất thường về chức năng, bạn nên kiểm tra dụng cụ đo tại trung tâm dịch vụ có thẩm quyền của Bosch.

Vận hành Ban đầu

Tắt và Mở

Hãy gấp nắp dây bảo vệ lên để đo **1. Khi làm việc hãy đảm bảo rằng vùng đo hồng ngoại không bị đóng kín hoặc bị che.**

Để **Bật** máy, bạn hãy ấn phím **bật – tắt 9**. Trên màn hình **14** xuất hiện một trình tự khởi động. Sau thứ tự khởi động, dụng cụ đo sẽ bắt đầu bằng việc đo và sẽ tiếp tục cho đến khi bị tắt.

Ghi Chú: Trong vài phút đầu tiên, dụng cụ đo có thể tự điều chỉnh, bởi vì nhiệt độ cảm biến và nhiệt độ xung quanh vẫn chưa được điều chỉnh. Việc hiệu chỉnh lại sẽ cho phép đo chính xác. Trong lúc hiệu chỉnh ảnh nhiệt sẽ đóng băng trong thời gian ngắn.

Để **Tắt** máy, bạn hãy ấn lại phím **bật – tắt**. Máy đo sẽ lưu tất cả thiết lập và sau đó tự ngắt. Hãy đóng nắp dây bảo vệ **1** để vận chuyển an toàn dụng cụ đo.

Trong menu điều chỉnh bạn có thể chọn xem dụng cụ được tắt sau thời gian nào (xem “Thời gian tắt”, trang 70).

Nếu pin hoặc máy đo nằm ngoài nhiệt độ vận hành đã cho trong thông số kỹ thuật, thì máy đo sẽ tự động ngắt sau một cảnh báo ngắn (xem hình “Xử Lý Hồng Hộc – Nguyên Nhân và Biện Pháp Chính Sửa”, trang 71). Để máy đo thích nghi với nhiệt độ môi trường và bật lại lần nữa.

Chuẩn bị đo

Điều chỉnh độ phát xạ cho các phép đo nhiệt độ bề mặt

Các phát xạ của một vật phụ thuộc vào nguyên vật liệu và cấu trúc bề mặt của vật đó. Nó sẽ cho thấy liệu vật thể (so với các vật thể khác cùng nhiệt độ) có thể truyền nhiều hay ít Bức xạ nhiệt hồng ngoại.

Để xác định nhiệt độ bề mặt, bức xạ nhiệt hồng ngoại tự nhiên sẽ được đo không tiếp xúc, phát tới đối tượng mục tiêu. Để có các phép đo chính xác, phải kiểm tra độ phát xạ đã được điều chỉnh tại máy đo ở **mỗi phép đo** và có thể điều chỉnh tại đối tượng đo nếu có thể.

Bạn có thể chọn một trong nhiều độ phát xạ hoặc nhập một giá trị số chính xác. Hãy điều chỉnh độ phát xạ mong muốn qua Menu “**Đo**” > “**Độ phát xạ**” (xem trang 69).

- ▶ **Chỉ có các phép đo nhiệt độ chính xác, nếu thống nhất được độ phát xạ đã điều chỉnh và độ phát xạ của đối tượng.**

Các khác biệt màu có thể được phân bố cho nhiều mức nhiệt độ khác nhau và/hoặc nhiều độ phát xạ khác nhau. Nếu các độ phát xạ khác biệt nhiều thì các khác biệt về nhiệt độ đã hiển thị có thể sai lệch đáng kể với giá trị thực.

Nếu có càng nhiều đối tượng đo làm từ nhiều loại nguyên vật liệu hoặc cấu trúc khác nhau trong một vùng đo, thì các giá trị nhiệt độ đã hiển thị chỉ bắt buộc ở những đối tượng đo phù hợp với độ phát xạ được điều chỉnh. Đối với tất cả đối tượng khác (với các độ phát xạ khác) các khác biệt về màu có thể được sử dụng dưới dạng hướng dẫn về tỷ lệ màu.

Vật liệu	Độ phát xạ (Trị số chuẩn 0 °C...100 °C)
Bê-tông	0,93
Vữa/hồ	0,93
Gạch	0,93
Giấy lợp nhà	0,93
Sơn tản nhiệt	0,93
Gỗ	0,91
Lốp lót sàn	0,88
Giấy	0,89

Ghi chú về các điều kiện đo

Các bề mặt phản chiếu lóa hoặc sáng chói (như gạch lát hoặc kim loại trơn) có thể làm sai hoặc gây ảnh hưởng đến các kết quả đã hiển thị. Hãy dán mặt đo lại bằng băng dính xin màu có thể dẫn nhiệt tốt nếu cần thiết. Hãy để băng dính cân bằng trên bề mặt một lát.

Chú ý tới góc đo thuận tiện tại các diện tích phản chiếu sao cho bức xạ nhiệt phản chiếu của vật thể khác không làm sai lệch kết quả đo. Ví dụ, khi đo mà

68 | Tiếng Việt

theo chiều dọc từ phía trước, hiện tượng phản chiếu nhiệt độ cơ thể của bạn có thể gây ảnh hưởng đến phép đo. Đối với một bề mặt phẳng thì các đường nét và nhiệt độ của cơ thể có thể được hiển thị (giá trị phản chiếu), xem nhiệt độ nào không tương ứng với bề mặt được đo (giá trị đã phát hoặc giá trị thực của bề mặt).

Về lý thuyết, không thể thực hiện phép đo qua chất liệu trong suốt (ví dụ như thủy tinh hoặc nhựa trong suốt).

Các kết quả đo sẽ càng chính xác và đáng tin cậy khi các điều kiện đo tốt hơn và ổn định hơn.

Phép đo nhiệt độ bằng hồng ngoại có thể bị ảnh hưởng xấu bởi khói, hơi/độ ẩm không khí cao hoặc không khí bụi bặm.

Hướng dẫn về độ chính xác cao hơn của các phép đo:

- Hãy đến gần vật thể nhất để giảm thiểu các yếu tố gây nhiễu giữa ben và bề mặt đo.
- Bạn cần thông khí ở bên trong trước khi đo phòng này, đặc biệt khi không khí bị ô nhiễm hoặc rất ẩm thấp.
Hãy để căn phòng cân bằng sau khi thông khí, cho tới khi phòng đạt nhiệt độ thông thường.

Gán nhiệt độ dựa vào thang đo

Ở phía bên phải màn hình hiển thị một thang đo được hiển thị. Các giá trị ở đầu trên và đầu dưới sẽ là nhiệt độ tối đa hoặc tối thiểu thu được trong ảnh nhiệt. Sự chỉ định màu cho một giá trị nhiệt độ trong ảnh được thực hiện đồng đều (tuyến tính).

Với nhiều tông màu khác nhau, các mức nhiệt độ sẽ được chỉ định cho cả hai giá trị biên này. Mức nhiệt độ, mà nằm giữa giá trị tối thiểu và tối đa, có thể được chỉ định cho vùng màu giữa của thang đo.

Để xác định nhiệt độ của vùng cụ thể bạn hãy di chuyển thiết bị đo, để đường chữ thập có hiển thị nhiệt độ I chỉ vào vào điểm mong muốn hoặc vùng mong muốn.

Trong thiết lập tự động, quang phổ màu của thang đo luôn được phân bố tuyến tính (đồng đều) lên toàn bộ vùng đo trong nhiệt độ tối thiểu hoặc tối đa.

Trong camera ảnh nhiệt tất cả các nhiệt độ đã đo sẽ được hiển thị trong vùng đo tỷ lệ với nhau. Nếu, trong một vùng, ví dụ trong hiển thị màu, mà nhiệt được hiển thị màu xanh dương trong bảng màu, thì tức là vùng xanh dương thuộc các giá trị đo lạnh trong vùng đo hiện tại. Tuy nhiên các vùng này có thể vẫn nằm trong khoảng nhiệt độ, mà có thể dẫn đến thương tích. Do đó hãy lưu ý các nhiệt độ đã hiển thị trên thang đo hoặc trên đường chữ thập.



Chức năng

Điều chỉnh hiển thị màu

Tùy theo tình huống đo mà các bảng màu khác biệt có thể giúp phân tích ảnh nhiệt và minh họa đối tượng hoặc thực trạng rõ ràng hơn trong màn hình hiển thị. Do đó nhiệt độ đo được không bị ảnh hưởng. Chỉ có hiển thị giá trị nhiệt độ là thay đổi.

Để thay đổi bảng màu bạn hãy duy trì chế độ đo và nhấn nút mũi tên bên phải **8** hoặc bên trái **12**.

Giao thoa ảnh nhiệt và ảnh thực

Để định hướng tốt hơn (= bố trí không gian cho ảnh nhiệt đã hiển thị) một ảnh thực trực quan sẽ được bật bổ sung đối với các khoảng nhiệt độ cân chỉnh.

Ghi Chú: Giao thoa ảnh nhiệt và ảnh thực là chính xác ở khoảng cách 0,55 m. Nếu cách khoảng cách tới đối tượng đo bị chênh lệch thì có thể dẫn đến sai lệch giữa ảnh nhiệt và ảnh thực.

Camera Ảnh nhiệt cho bạn các khả năng sau:

- **100 % Ảnh hồng ngoại**
Chỉ ảnh nhiệt được hiển thị.
- **Ảnh lồng Ảnh**
Ảnh nhiệt đã hiển thị được cắt bớt và vùng xung quanh được hiển thị dưới dạng ảnh thực. Thiết lập này sẽ cải thiện việc bố trí vùng đo.
- **Độ trong suốt**
Ảnh nhiệt đã hiển thị được đặt trên ảnh thực với độ trong suốt. Như vậy các đối tượng có thể được nhận diện tốt hơn.

Bằng cách nhấn nút mũi tên bên trên **5** hoặc bên dưới **10** bạn có thể điều chỉnh thiết lập.

Cổ định thang đo

Điều chỉnh sự phân bố màu trong ảnh nhiệt sẽ được thực hiện tự động, tuy nhiên việc này có thể bị đóng băng do nhấn nút chức năng bên phải **7**. Điều này cho phép so sánh các ảnh nhiệt đã được ghi lại theo các điều kiện nhiệt độ khác nhau (ví dụ khi kiểm tra nhiều không gian trên cầu nhiệt).

Để chuyển thang đo sang tự động, hãy nhấn lại nút chức năng bên phải **7**. Các nhiệt độ được xử lý động và được điều chỉnh phù hợp với các giá trị tối thiểu và tối đa.

Các chức năng đo

Để mở các chức năng khác, mà có thể hữu ích khi hiển thị, hãy nhấn nút **"Func"** **6**. Hãy điều hướng đến các tùy chọn được hiển thị bằng bên phải/bên trái, để chọn một chức năng. Hãy chọn một chức năng và nhấn lại nút **"Func"** **6**.

Các chức năng đo sau sẵn có cho bạn:

- **“Tự động”**
Sự phân bố màu trong ảnh nhiệt được thực hiện tự động.
- **“Máy tìm nóng”**
Trong chức năng đo này chỉ các nhiệt độ cao trong vùng đo mới được hiển thị dưới dạng ảnh nhiệt. Vùng bên ngoài các nhiệt độ cao này được hiển thị dưới dạng ảnh thực trong hình ảnh thang độ xám, để không kết nối sai đối tượng màu với nhiệt độ (ví dụ cáp đỏ trong buồng chuyển mạch khi tìm kiếm các phần tử bị quá nhiệt). Hãy điều chỉnh thang độ bằng các nút trên **5** và dưới **10**. Do đó khoảng nhiệt độ đã hiển thị được mở rộng hoặc thu nhỏ.
Thiết bị sẽ tiếp tục đo các nhiệt độ tối thiểu và tối đa và hiển thị chúng ở đầu cuối của thang đo. Nhưng bạn có thể điều khiển, khoảng nhiệt độ nào cần được hiện màu dưới dạng ảnh nhiệt.
- **“Máy tìm lạnh”**
Trong chức năng đo này chỉ các nhiệt độ thấp trong vùng đo mới được hiển thị dưới dạng ảnh nhiệt. Vùng bên ngoài các nhiệt độ thấp này được hiển thị dưới dạng ảnh thực trong hình ảnh thang độ xám, để không kết nối sai đối tượng màu với nhiệt độ (ví dụ khung cửa sổ màu xanh dương khi tìm kiếm lớp cách nhiệt lỗi). Hãy điều chỉnh thang độ bằng các nút trên **5** và dưới **10**. Do đó khoảng nhiệt độ đã hiển thị được mở rộng hoặc thu nhỏ.
Thiết bị sẽ tiếp tục đo các nhiệt độ tối thiểu và tối đa và hiển thị chúng ở đầu cuối của thang đo. Nhưng bạn có thể điều khiển, khoảng nhiệt độ nào cần được hiện màu dưới dạng ảnh nhiệt.
- **“Thủ công”**
Nếu các nhiệt độ chênh lệch mạnh trong ảnh nhiệt được đo (ví dụ thiết bị sưởi ấm dưới dạng đối tượng nóng khi kiểm tra cầu nhiệt), thì các màu sẵn có sẽ được phân bố cho nhiều giá trị nhiệt độ trong khoảng giữa mức nhiệt độ tối đa và tối thiểu. Điều này có thể dẫn đến, các chênh lệch nhiệt độ tinh không được hiển thị chi tiết. Để hiển thị chi tiết nhiệt độ tập trung, hãy tiến hành như sau: Sau khi bạn chuyển sang chế độ **“Thủ công”**, bạn có thể điều chỉnh nhiệt độ tối đa hoặc tối thiểu. Bạn có thể ấn định khoảng nhiệt độ, mà quan trọng với bạn và bạn muốn nhận diện sự chênh lệch tinh. Thiết lập **Reset** sẽ tự động điều chỉnh thang đo phù hợp với các giá trị đo được trong trường quan sát của cảm biến hồng ngoại.

Menu chính

Để đến menu chính, hãy nhấn phím **“Func” 6** để mở các chức năng đo. Hãy nhấn nút chức năng bên phải **7**.

- **“Đo”**
 - **“Độ phát xạ” c:**
Đối với một vài nguyên vật liệu thông dụng nhất, có thể lựa chọn độ phát xạ đã lưu. Chọn nguyên vật liệu thích hợp trong mục menu **“Nguyên liệu”**. Độ phát xạ phù hợp sẽ được hiển thị trong dòng bên dưới.
Khi bạn đã biết độ phát xạ chính xác của đối tượng đo, bạn có thể điều chỉnh độ phát xạ cũng như các giá trị số trong mục menu **“Độ phát xạ”**.
 - **“Nhiệt độ được phản ánh”:**
Thiết lập của thông số này sẽ cải thiện kết quả đo khi vật liệu có độ phát xạ thấp (= Phản xạ cao). Nhiệt độ được phản xạ thường tương ứng với nhiệt độ xung quanh.
Nếu các đối tượng có nhiệt độ chênh lệch mạnh ở gần các đối tượng phản chiếu mạnh có thể gây ảnh hưởng đến phép đo, thì giá trị này cần được điều chỉnh.
- **“Màn hình hiển thị”**
 - **“Điểm nóng” k: “BẬT/TẮT”**
Trong chức năng này điểm nóng nhất trong vùng đo sẽ được đánh dấu tự động bằng một đường chữ thập trong ảnh nhiệt. Điều này có thể cho phép bạn nhận diện vị trí quan trọng, ví dụ một thiết bị đầu cuối lỏng trong buồng chuyển mạch.
 - **“Điểm lạnh” m: “BẬT/TẮT”**
Điểm lạnh trong vùng đo được đánh dấu tự động bằng đường chữ thập màu xanh dương trong ảnh nhiệt. Điều này có thể cho phép bạn nhận diện vị trí quan trọng, ví dụ một vị trí không kín trong lớp cách nhiệt.
 - **“Đường chữ thập” l: “BẬT/TẮT”**
Đường chữ thập được hiển thị ở giữa ảnh nhiệt và cho bạn biết giá trị nhiệt độ đã đo ở vị trí này.
 - **“Thước” h: “BẬT/TẮT”**
- **“WiFi”:** **“BẬT/TẮT”**
(xem “Truyền dữ liệu”, trang 70)
- **“Track My Tools”:** **“BẬT/TẮT”**
(xem “TrackMyTools”, trang 72)
- **“Thiết bị”**
 - **“Ngôn ngữ”**
Dưới mục menu này bạn có thể điều chỉnh ngôn ngữ của tất cả hiển thị.

70 | Tiếng Việt

– “Thời gian & Ngày tháng” a

Để thay đổi ngày giờ trên màn hình, bạn hãy gọi lên menu phụ “**Thời gian & Ngày tháng**”.

Ngoài ra, định dạng thời gian và ngày tháng cũng có thể thay đổi.

Để rời menu phụ “**Thời gian & Ngày tháng**”, bạn có thể nhấn phím chức năng trái **13** dưới biểu tượng Lưỡi câu, để lưu các thiết lập, hoặc phím chức năng phải **7** dưới biểu tượng X, để bỏ các thay đổi này.

– “Tín hiệu âm”: “BẬT/TẮT”

Dưới mục menu này bạn có thể bật/tắt âm tín hiệu.

– “Thời gian tắt”

Dưới mục menu này bạn có thể chọn khoảng thời gian để sau khoảng thời gian đó, máy đo cần tự động ngắt nếu không có phím nào được bấm. Bạn cũng có thể bỏ kích hoạt ngắt tự động bằng cách chọn thiết lập “**Không bao giờ**”.

– “Xóa tất cả ảnh”

Dưới mục menu này, bạn có thể xóa tất cả hình ảnh trong bộ nhớ trong cùng một lúc. Hãy nhấn phím mũi tên phải **8** cho “**hơn nữa...**”, để đi tới menu phụ. Hãy nhấn phím chức năng trái **13** dưới biểu tượng Lưỡi câu, để xóa toàn bộ dữ liệu hoặc phím mũi tên phải **7** dưới biểu tượng X, để hủy quá trình.

– “Thông tin thiết bị”

Dưới mục menu này bạn có thể phục hồi các thông tin qua dụng cụ đo. Ở đó, bạn sẽ tìm thấy số sê-ri của máy đo và phiên bản phần mềm được cài đặt.

Để rời Menu ngẫu nhiên và quay trở lại màn hình hiển thị chuẩn, bạn cũng có thể nhấn phím **17**.

Tài liệu về kết quả đo

Lưu kết quả đo

Ngay sau khi bật, dụng cụ đo sẽ bắt đầu bằng việc đo và sẽ tiếp tục cho đến khi bị tắt.

Để lưu ảnh, hãy hướng camera vào đối tượng đo mong muốn và nhấn nút lưu **11**. Ảnh được lưu trong bộ nhớ trong của camera. Ngoài ra hãy nhấn nút đóng băng đo **17**. Phép đo được đóng băng và hiển thị trong màn hình hiển thị. Điều này cho phép bạn quan sát tĩnh các ảnh. Nếu bạn không muốn lưu ảnh đã đóng băng, hãy nhấn nút **17** để trở về chế độ đo. Nếu bạn muốn lưu ảnh trong bộ nhớ của camera, hãy nhấn nút lưu **11**.

Mở các ảnh đã lưu

Để mở các ảnh nhiệt đã lưu hãy thực hiện như sau:

- Hãy nhấn nút chức năng bên trái **13**. Trên màn hình bây giờ sẽ xuất hiện ảnh đã được lưu gần nhất.
- Nhấn phím mũi tên phải **8** hoặc trái **12**, để đổi các ảnh nhiệt đã lưu.

Xóa các ảnh đã lưu

Để xóa từng ảnh nhiệt hãy đi đến khung nhìn bộ sưu tập:

- Hãy nhấn nút chức năng phải **7** dưới biểu tượng Thùng rác.
- Hãy xác nhận quá trình bằng nút chức năng bên trái **13** hoặc hủy quá trình xóa bằng cách nhấn nút chức năng bên phải **7** ở dưới biểu tượng hủy.

Xóa tất cả hình ảnh

Trong menu “**Xóa tất cả ảnh**”, bạn có thể xóa tất cả hình ảnh trong bộ nhớ trong cùng một lúc.

Hãy nhấn nút “**Func**” **6** để mở các chức năng đo.

Giờ hãy nhấn nút chức năng bên phải **7** và chọn “**thiết bị**” > “**Xóa tất cả ảnh**”. Để đi tới menu phụ đó **8**, bạn hãy nhấn phím mũi tên phải. Hãy nhấn phím chức năng trái **13** dưới biểu tượng Lưỡi câu, để xóa toàn bộ dữ liệu hoặc phím mũi tên phải **7** dưới biểu tượng X, để hủy quá trình.

Truyền dữ liệu

Truyền dữ liệu thông qua giao diện USB

Mở nắp đậy của jack nối Micro-USB **3**. Kết nối jack cắm Micro USB của máy đo qua dây cáp Micro USB kèm theo vào máy tính hoặc máy tính di động của bạn.

Bật camera ảnh nhiệt với nút **9**.

Mở trình duyệt tập tin và chọn ổ đĩa “**BOSCH GTC 400 C**”. Trên máy tính bạn có thể copy, di chuyển hoặc xóa các dữ liệu JPG đã lưu tại bộ nhớ trong.

Ngay khi bạn kết thúc quá trình mong muốn, hãy tách riêng ổ đĩa và tắt camera ảnh nhiệt bằng nút **9**.

Thấp cáp Micro-USB trong khi vận hành đo và đóng nắp đậy **3**.

Chú ý: Trước hết hãy thoát khỏi ổ đĩa từ hệ điều hành của bạn (thoát ổ đĩa), nếu không bộ nhớ trong của camera ảnh nhiệt có thể bị hỏng.

Luôn đóng kín nắp che của giao diện USB, để không có bụi hoặc nước phun xâm nhập vào vỏ bọc.

Ghi Chú: Bạn chỉ có thể kết nối máy đo với một PC hoặc Notebook. Thiết bị có thể bị hư hỏng, nếu bạn kết nối nó với một thiết bị khác.

Ghi Chú: Giao diện Micro-USB chỉ dùng để truyền dữ liệu – pin và ắc quy có thể không được sạc qua đó.

Xử lý tiếp ảnh nhiệt

Bạn có thể xử lý tiếp các ảnh nhiệt đã lưu trên máy tính có hệ điều hành Windows. Hãy tải xuống phần mềm GTC-Transfer từ trang sản phẩm của camera ảnh nhiệt tại www.bosch-professional.com/gtc.

Truyền dữ liệu qua WiFi

Dụng cụ đo được trang bị một mô-đun WiFi, mà cho phép truyền ảnh đã lưu không dây từ camera ảnh nhiệt lên thiết bị đầu cuối di động.

Do đó cần có ứng dụng (App) “**Measuring Master**” để làm giao diện phần mềm. Tùy theo thiết bị đầu cuối, bạn có thể tải những ứng dụng này trong các kho lưu trữ thích hợp:







Bên cạnh việc truyền dữ liệu không dây cho ảnh của bạn, ứng dụng “**Measuring Master**” còn cho phép một phạm vi chức năng mở rộng và đơn giản hóa việc xử lý tiếp cũng như việc chuyển tiếp các dữ liệu đo (qua E-Mail). Các thông tin về điều kiện hệ thống cần thiết cho việc kết nối WiFi có thể tìm thấy trên trang Web của Bosch theo địa chỉ “www.bosch-professional.com/gtc”.

Để kích hoạt/vô hiệu hóa kết nối WiFi tại dụng cụ đo, hãy mở menu chính, điều hướng bằng nút chọn “**WiFi**” và kích hoạt/vô hiệu hóa nó. Trên màn hình xuất hiện đèn chỉ thị **e**. Hãy chắc chắn rằng, giao diện WiFi trên thiết bị di động đầu cuối của bạn đã được kích hoạt.

Sau khi khởi động ứng dụng Bosch (ở mô-đun WiFi đã kích hoạt), kết nối giữa thiết bị đầu cuối và máy đo có thể được thiết lập. Do đó hãy tuân theo các hướng dẫn của ứng dụng “**Measuring Master**”.

Xử Lý Hỏng Hóc – Nguyên Nhân và Biện Pháp Chính Sửa

Nếu có trục trặc thiết bị sẽ tiến hành khởi động lại và có thể được sử dụng lại trong kết nối. Ngoài ra, tổng quan dưới đây có thể giúp bạn khi có thông báo lỗi liên tục.

Lỗi	Nguyên nhân	Biện pháp Chính Sửa
Không thể bật được dụng cụ đo.	Pin hoặc pin rỗng	Hãy nạp pin hoặc đổi pin.
	Pin quá nóng hoặc quá lạnh	Hãy để pin cân bằng hoặc đổi pin.
	Máy đo quá nóng hoặc quá lạnh	Hãy để máy đo cân bằng.
	Bộ nhớ ảnh lỗi	Hãy định dạng bộ nhớ trong, qua đó xóa toàn bộ các hình ảnh (xem hình “Xóa tất cả hình ảnh”, trang 70). Nếu vẫn còn tồn tại vấn đề, hãy gửi máy đo tới trung tâm bảo hành có thẩm quyền của Bosch.
	Bộ nhớ ảnh đầy	Theo nhu cầu, hãy chuyển ảnh tới một phương tiện lưu trữ khác (ví dụ như máy tính hoặc Notebook). Sau đó xóa các hình ảnh trong bộ nhớ trong.
	Máy đo bị lỗi	Hãy gửi máy đo đến trung tâm bảo hành được ủy quyền của Bosch.
Máy đo không thể kết nối với máy tính.	Máy tính không thể nhận ra máy đo.	Hãy kiểm tra trình điều khiển trên máy tính của bạn đã cập nhật chưa. Nếu có thể, cần cập nhật phiên bản hệ điều hành mới hơn trên máy tính.
	Kết nối Micro USB hoặc cáp Micro USB bị lỗi	Hãy kiểm tra máy đo có kết nối với máy tính khác hay không. Nếu không, hãy gửi máy đo đến trung tâm bảo hành được ủy quyền của Bosch.

72 | Tiếng Việt

Giải thích khái niệm**Bức xạ nhiệt hồng ngoại**

Bức xạ nhiệt hồng ngoại là bức xạ điện từ phát ra từ mỗi cơ thể. Lượng bức xạ phụ thuộc vào nhiệt độ và độ phát xạ của cơ thể.

Độ phát xạ

Các phát xạ của một vật phụ thuộc vào nguyên vật liệu và cấu trúc bề mặt của vật đó. Độ phát xạ cho thấy, lượng bức xạ hồng ngoại của vật thể so với một bộ tản nhiệt lý tưởng nhiệt (vật thể màu đen có độ phát xạ $\epsilon=1$).

Cấu nhiệt

Cấu nhiệt để mô tả một vật thể mà dẫn nhiệt không mong muốn ra ngoài hoặc vào trong và có khác biệt đáng kể so với nhiệt độ còn lại hoặc mong muốn của một bức tường.

Do nhiệt độ bề mặt tại cấu nhiệt thấp hơn so với nhiệt độ phòng thông thường, nên rủi ro lên mốc tăng lên đáng kể.

Nhiệt độ được phản xạ/tính phản xạ của đối tượng

Nhiệt độ được phản xạ là những bức xạ nhiệt, không tự phát ra từ đối tượng. Tùy thuộc vào cấu trúc và vật liệu mà các bức xạ phản xạ được phản xạ trong đối tượng cần đo và do đó làm sai kết quả nhiệt độ thực.

Khoảng cách của đối tượng

Khoảng cách giữa đối tượng đo và thiết bị đo ảnh hưởng đến kích thước bề mặt thu được mỗi Pixel. Với khoảng cách lớn của đối tượng, bạn có nhận diện đối tượng lớn.

Khoảng cách (m)	Kích thước điểm ảnh hồng ngoại (mm)	Vùng hồng ngoại Chiều rộng x chiều cao (m)
0,5	3	~0,5 x 0,4
1	6	~1 x 0,75
2	12	2,05 x 1,5
5	30	5,1 x 3,8

TrackMyTools

Bluetooth[®] Low Energy Module tích hợp sẵn giúp tùy biến và kiểm tra trạng thái của một dụng cụ đo cũng như truyền đi các cài đặt và dữ liệu dựa trên công nghệ sóng vô tuyến *Bluetooth*[®].

Bộ nguồn TrackMyTools-Mô-đun-Bluetooth[®]

Dụng cụ đo được trang bị một pin cúc áo, để nó có thể được phát hiện mà không cần ắc quy **23** hay pin được gài qua TrackMyTools bởi một thiết bị đầu cuối di động.

Bạn sẽ có được các thông tin tiếp theo trong ứng dụng của Bosch.

Truyền dữ liệu

Bạn có thể bật hoặc tắt mô-đun TrackMyTools-*Bluetooth*[®] theo các điều chỉnh thiết bị. Sau đó nó sẽ phát ra một tín hiệu liên tục.

Khoảng thời gian truyền đi của mô-đun là tám giây. Tùy thuộc vào môi trường xung quanh mà cần có tối đa ba khoảng thời gian truyền, trước khi dụng cụ đo được nhận diện.

Ghi Chú: Hãy tắt TrackMyTools, nếu bạn đang ở trong vùng mà việc truyền sóng radio bị cấm, ví dụ trong máy bay.

Đăng ký và thiết lập ứng dụng/ứng dụng web

Để có thể sử dụng TrackMyTools, bạn phải đăng ký trực tuyến.

Do đó hãy mở trang web

www.bosch-trackmytools.com và đăng ký. Sau khi hoàn thành đăng ký bạn sẽ nhận được dữ liệu truy cập.

Tải ứng dụng **TrackMyTools** qua kho ứng dụng tương ứng (Apple App Store, Google Play Store) hoặc mở ứng dụng web qua <https://web.bosch-trackmytools.com>. Ở đây bạn có thể đăng nhập bằng dữ liệu truy cập.

Giờ bạn có thể tạo và quản lý thư mục bằng ứng dụng/ứng dụng web.

Ghi Chú: Trước hết hãy thực hiện đầy đủ hướng dẫn của ứng dụng/ứng dụng web. Do đó bạn sẽ có cái nhìn tổng quan tốt hơn về biện pháp khi tạo thư mục và về việc điều khiển phần mềm.

Bảo Dưỡng và Bảo Quản**Bảo Dưỡng Và Làm Sạch**

Chỉ cất và vận chuyển máy đo trong hộp phù hợp như bao bì ban đầu hoặc túi bảo vệ (phụ kiện). Không dán băng keo gắn cảm biến hồng ngoại trên máy đo.

Luôn luôn giữ cho dụng cụ đo thật sạch sẽ.

Tuyệt đối không để nước rò vào máy trong quá trình làm sạch.

Không thử dùng vật nhọn để lấy chất bẩn khỏi các cảm biến, camera hoặc ống kính thu, và không lau qua camera và ống kính thu (rủi ro gây xước).

Nếu bạn muốn hiệu chỉnh lại dụng cụ đo của bạn, hãy liên hệ với trung tâm dịch vụ Bosch (Địa chỉ xem phần "Dịch Vụ Sau Khi Bán và Dịch Vụ Ứng Dụng").

Trong trường hợp cần sửa chữa, hãy gửi máy đặt trong bao bì ban đầu hoặc túi bảo vệ (phụ kiện).

Chỉ cho phép kỹ thuật viên tháo pin cúc áo tích hợp để thải bỏ. Mở vỏ bọc có thể làm hỏng máy. Hãy xoay vít tại vỏ máy ra và gỡ bỏ lớp vỏ bọc để tháo pin cúc áo.

Dịch Vụ Sau Khi Bán và Dịch Vụ Ứng Dụng

Bộ phận phục vụ hàng sau khi bán của chúng tôi sẽ trả lời các câu hỏi liên quan đến việc bảo trì và sửa chữa các sản phẩm cũng như các phụ tùng thay thế của bạn. Hình ảnh chi tiết và thông tin phụ tùng thay thế có thể tìm hiểu theo địa chỉ dưới đây:

www.bosch-pt.com

Bộ phận dịch vụ ứng dụng Bosch sẽ hân hạnh trả lời các câu hỏi liên quan đến các sản phẩm của chúng tôi và linh kiện của chúng.

Trong tất cả các phản hồi và đơn đặt phụ tùng, xin vui lòng luôn luôn nhập số hàng hóa 10 chữ số theo nhãn của hàng hóa.

Việt Nam

CN Cty TNHH Bosch Vietnam tại TP. Ho Chi Minh
Tầng 10, Tòa nhà 194 Golden
473 Điện Biên Phủ
Phường 25, Quận Bình Thạnh
Tp. Hồ Chí Minh
Tel.: (08) 6258 3690
Fax: (08) 6258 3692
Hotline: (08) 6250 8555
www.bosch-pt.com.vn

Campuchia

Công ty TNHH Robert Bosch (Campuchia)
Đơn nguyên 8BC, GT Tower, Tầng 08,
Đường 169, Tiệp Khắc Blvd, Sangkat Veal Vong,
Khan 7 Makara, Phnom Penh
VAT TIN : 100 169 511
Tel.: +855 23 900 685
Tel.: +855 23 900 660
www.bosch.com.kh

Vận Chuyển

Pin hợp khối lithium-ion sử dụng được là đối tượng nằm trong luật Qui Định Hàng Hóa Nguy Hiểm. Người sử dụng có thể vận chuyển pin hợp khối bằng đường bộ mà không cần thêm yêu cầu nào khác. Khi được vận chuyển do bên thứ ba thực hiện (vd. vận chuyển bằng đường hàng không hay thông qua đại lý vận chuyển), các yêu cầu đặc biệt về việc đóng gói và dán nhãn phải được tuân thủ. Để chuẩn bị hàng hóa được gửi đi, cần tham khảo chuyên gia về vật liệu nguy hiểm.

Chỉ gửi pin hợp khối khi vỏ ngoài không bị hư hỏng. Dán băng keo hay che kín các điểm tiếp xúc hở và đóng gói pin hợp khối theo cách sao cho pin không thể xê dịch khi nằm trong bao bì. Ngoài ra, xin vui lòng chấp hành các qui định chi tiết có thể được bổ sung thêm của quốc gia.

Thải bỏ



Máy đo, ắc quy/pin, phụ kiện và bao bì cần được tái sử dụng theo quy định về môi trường.



Không được thải bỏ dụng cụ đo và pin/pin nạp điện lại được vào chung với rác sinh hoạt!

Pin lốc/pin:

Li-ion:

Xin vui lòng tuân thủ theo thông tin dưới đây “Vận Chuyển”, trang 73.

Được quyền thay đổi nội dung mà không phải thông báo trước.